

JIM WOLF TECHNOLOGY, INC.

350Z TWIN TURBO SYSTEM

2003-4 MANUAL TRANS.

INSTALLATION MANUAL



Please read this entire guide before beginning. This installation must only be performed by a competently trained technician possessing the factory manual for this vehicle and all of the tools and knowledge required to safely and successfully complete this specific work. This turbocharger kit has been engineered to provide the highest level of reliability achievable in an aftermarket upgrade and relies heavily on the ability of the installer to achieve this. If Jim Wolf Technology, Inc has not previously trained the installer on this installation, it is recommended that the qualified installer contact JWT before attempting this work. See www.jimwolftechnology.com updates to this manual.

All references to "LEFT" and "RIGHT" are from the driver's perspective. All open ends of the tubes must be covered at all times during the installation to avoid foreign objects from entering the system. All new parts must be completely inspected to insure no foreign debris or shipping material is present before installing. Wear eye and hand protection during all phases of this installation. It is recommended that synthetic oil and colder spark plugs be used in this engine after this upgrade is performed. Use Nissan #22401-5M016 (NGKPLFR6A-11) spark plugs.



**JWT G35 / 350Z TWIN TURBO
PLUMBING ID CHART**

T=TUBING PARTS
H=HOSE OR COUPLING
O=OIL IN OR OIL DRAIN

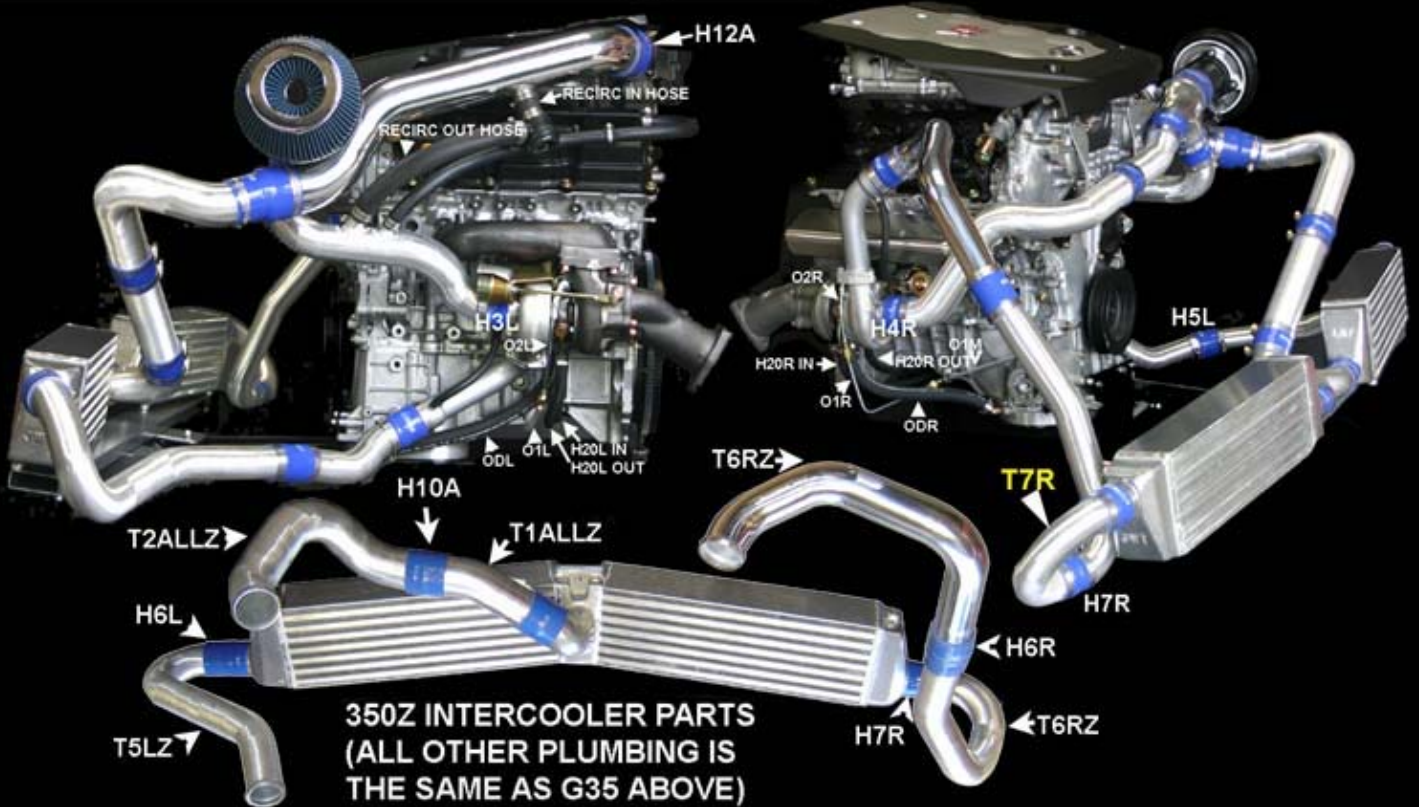
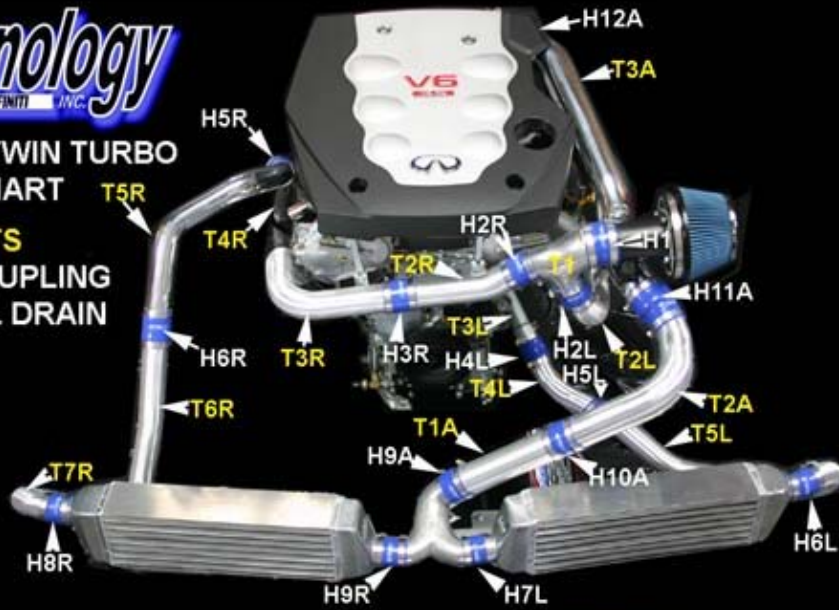

1. Perform the following preparatory work:

- ❑ Insure that the fuel tank is **less than ½ full** and that it contains **91 or higher octane gas**.
- ❑ Safely support the vehicle off the ground for easy access under the car.
- ❑ Disconnect the battery ground cable
- ❑ Remove the body nose from the car.
- ❑ Remove the plastic air deflector shields under the engine and radiator area of the chassis.
- ❑ Remove the air filter, air scoop,, MAF sensor, and the intake tube to the throttle.
- ❑ Remove the plastic engine shroud on top of the engine.
- ❑ Remove the plastic coolant recover tank and hose.
- ❑ Remove the windshield cleaner reservoir tank.
- ❑ Remove the cross member support assembly behind the cross member.
- ❑ Unbolt, but don't remove the steering rack, just pull it down slightly to get around it. Mark the steering shaft coupling and disconnect the shaft from the rack. Do not rotate the steering wheel during the time this is disconnected. This can damage the spiral cable in the steering column.
- ❑ Drain the engine oil and coolant.
- ❑ This is a good point to install the colder spark plugs recommended earlier.
- ❑ Remove the upper radiator hose and the metal water pipe it connects to on the engine.
- ❑ Remove the metal heater bypass tube from the left side of the engine.
- ❑ Remove the oil dipstick guide.
- ❑ Remove the alternator and starter wiring harness support brackets and discard them.

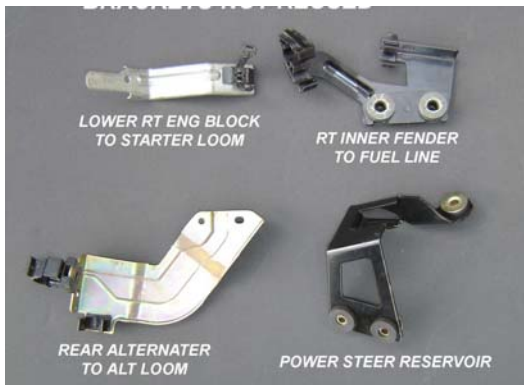

- ❑ Loosen the AC drive belt and remove the air conditioning compressor-mounting bolts, but leave the compressor in place. It does not need to be discharged or removed completely.
- ❑ Remove the catalytic converters and exhaust manifolds (unscrew the O2 sensors). Retain the metal gaskets, as they will be reused.
- ❑ **Remove all upper 6 exhaust manifold studs and the right lower rear stud from the heads. Shorten them by 2 threads to clear the new manifolds and reinstall them.** Use 2 nuts tightened against each other to avoid damaging the threads during reinstallation.

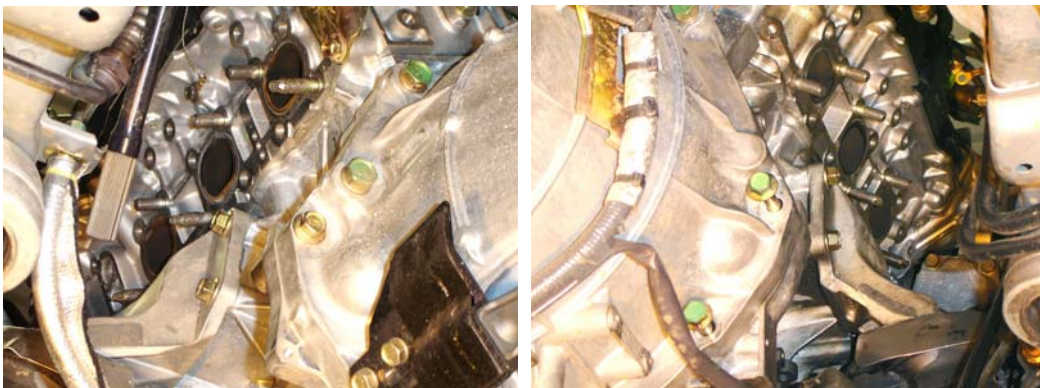

2. **Remove the lower oil pan and oil pickup tube.** Using Teflon thread sealant or RTV silicone sealant, install the 45 deg. brass drain fitting in the right side of the supplied aluminum pan spacer, indexed to approximately 10 o'clock. Install the 90 deg. fitting on the left side, indexed to 3 o'clock. Install the oil

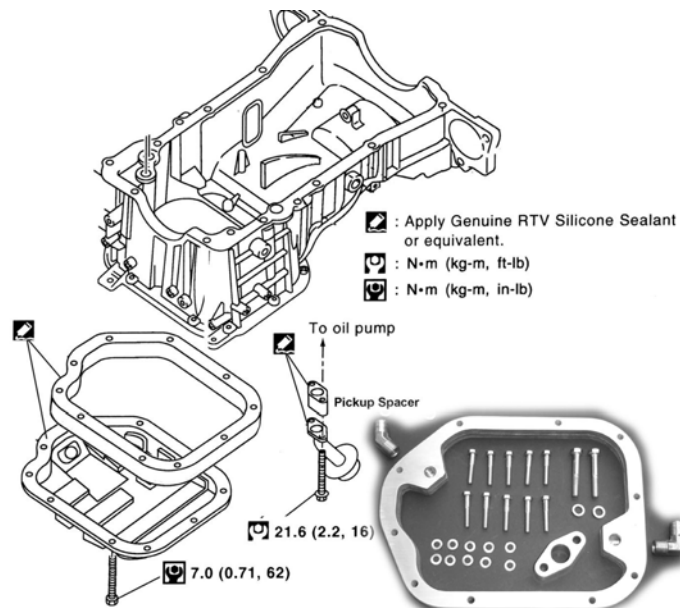

1. Drain oil and remove the sub-pan. Use a thin putty knife to separate the sealing surfaces.
2. Remove the oil pickup tube and reinstall it with the supplied spacer and bolts as shown. Do not get excess sealant inside the pickup tube.
3. Install the pan spacer and supplied longer bolts using RTV Sealant as shown.
4. Allow the sealant to dry for at least 30 min. before filling oil.
5. Oil capacity is now 6 quarts (original was 5 qt w/ oil filter change).

pickup tube spacer and the aluminum oil pan spacer using RTV Silicone Sealant or equivalent. Torque the supplied pickup tube bolts to 16 **ft**/lb and the pan bolts to 62 **in**/lb.

Remove and discard the upper fuel line bracket on the right inner fender well and carefully bend the metal fuel line upwards to match the hose next to it (Evap. line). Using the supplied Thermal wrap material, completely wrap both lines along the right inner fender well. Starting from where the upper bracket was removed, wrap 2 complete turns to start and then over lap the thermal wrap by at least half of its width continuing to the lower bracket. Tuck the end of the Thermal wrap under the lower bracket before tightening the bracket bolt. This must be done carefully to insure that heat from the turbo system does not damage the lines, **which can cause a fire**. Also wrap the starter solenoid, and any hoses or wiring that are closer than 2" from the new manifold / turbocharger assemblies. Loosely wind safety wire around the Thermal wrap to insure that the wire only retains the Thermal wrap and does not touch or cut into any wires or hoses. Keep the Thermal wrap and retaining wire away from the starter wires, as it is electrically conductive and could cause a short circuit. Zip ties may be used to secure the Thermal wrap if it is further than 5" from any exhaust heat source. **Install the supplied metal heat shield** over the Thermal wrapped fuel lines as shown. **NOTE:** You can wait to install the metal fuel line shield until after the turbos and down pipes are in place to give more clearance while bolting them in.



3. Locate the supplied 1/4" oil feed lines and blow them out to insure that no debris enters the oiling system before assembly. Remove the front lower alternator bracket and the oil pressure-sending unit located next



to the oil filter. **Caution:** All tapered pipe threads should be sealed with a small amount of Teflon or RTV sealant on the threads, but **absolutely no excess sealant should enter the oiling system! Do not use sealant on any inverted flare connections.** Install the supplied brass restrictor fitting in the Tee fitting as

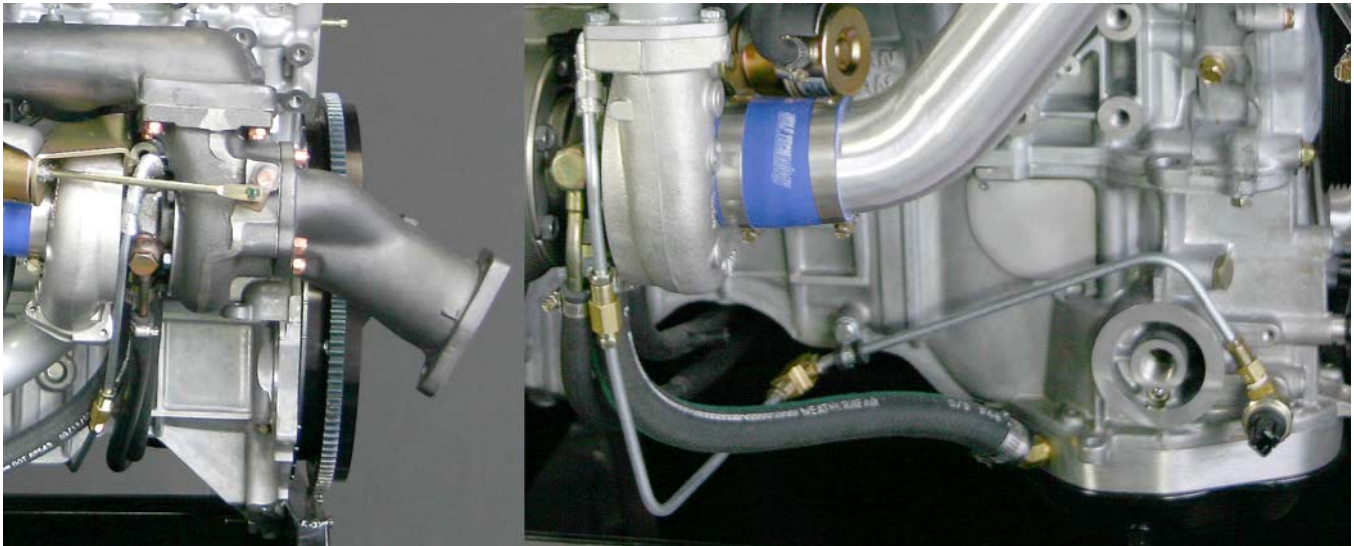

shown (if not already assembled in the kit). **Install the brass Tee / restrictor fitting assembly where the sending unit was**, with the restrictor port pointed at about 11 o'clock as shown. Install the sending unit in the other end of the Tee fitting and connect the electrical plug to the sending unit. Install the longest 1/4" oil line into the restrictor fitting and adjust and secure it using the supplied clamp to the side of the engine block where the starter wiring bracket was removed. Adjust this tube so that it does not touch or rub as it goes over the oil filter boss on the engine block as shown. Attach the supplied brass 1/4" inverted flare Tee at the other end of this oil line. Attach the left and right intermediate oil lines to the Tee as shown and attach the supplied 1/4" inverted flare couplings to the other end of both intermediate oil lines. Temporarily cover the open ends of the couplings. These couplings will be connect later to the final oil lines which you will preinstall on each turbo before they are bolted in place. Reinstall the lower alternator bracket.

4. Locate the coolant hose connected to the lower front of the oil cooler (the oil filter is mounted on it). Cut the hose as shown and **install the supplied large black plastic Tee** and attach the 5/16" rubber hose to the open leg using the supplied hose clamp (this is a snug fit, as this Tee leg is slightly larger than 5/16"). Route this new hose along the side of the engine and under the starter. Use the supplied cushion clamp to support this hose at the edge of the oil pan as shown. Install a 5/16" black plastic Tee at the other end of this hose so that the open legs of the Tee are parallel to the steering rack (they will connect to the turbo coolant fittings using 5/16" rubber hose later). Locate the original 8MM rubber coolant bypass hose that is directly behind the right cylinder head (it was also connected to the water pipe removed earlier). Cut

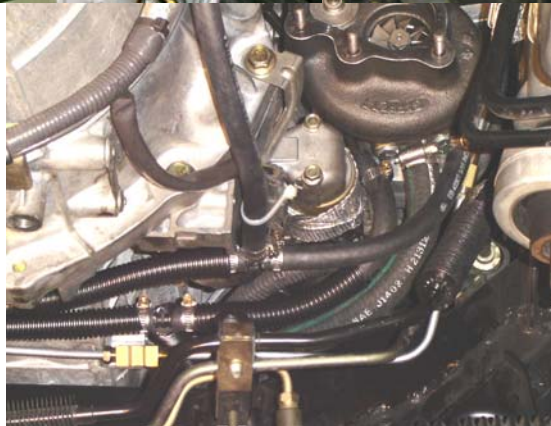

this hose just in the location directly above the wire harness attached to the right side of the transmission and install another 5/16" plastic Tee in this hose. Attach a 5/16" rubber hose to the open end of the Tee and route this hose downwards next to the wire harness attached to the right side of the transmission. Loop this hose toward the front of the car until it is next to the other hose and Tee you installed above the steering rack and install another 5/16" Tee in the end of this hose (the open legs of this Tee will also connect to the turbo coolant fittings later). It is important that all hoses and tubes are positioned and secured so they cannot contact other parts. Use the supplied black plastic hose covering where the hoses might touch other parts. Remember that the engine and the steering rack will move separate of each other. Check that all hose ends have clamps and are tightened correctly.

- 5. Install the manifolds.** Use a thin coat of anti-seize on all of the exhaust nuts. Install the qty 8 short M8 x 1.25 studs (10-12 fl/lb) into the new manifolds and install the manifolds using the original manifold gaskets. Check to see that all of the studs you shortened earlier clear the manifolds. Start all of the nuts before drawing the manifolds up to the heads and tighten them evenly a little at a time until the manifolds are tight (20-23 ft/lb). This is very important, as there is not enough clearance between all of the nuts and the manifolds until you are almost snug on the nuts. An open-end wrench is needed on some of the nut and should be tightened with a high grip 14mm open-end wrench like a **Snap-On Flank Drive Plus** to avoid rounding.



- 6. Pre-assembling the turbos.** Install the turbocharger coolant banjo fittings onto the turbochargers, pointing down, and inward as shown using the copper sealing washers on both sides of each banjo fitting. Install the 1/4" metal oil pressure lines onto the turbos. Make sure these lines are not touching the hot side of the turbos as best possible and final torque them using a 7/16" fitting wrench, as **they will be difficult to reach after the turbos are installed**. Install the oil drain fittings using silicone sealant and the supplied M8 bolts and lock washers. Final check that no packing material or foreign debris has entered any openings of the turbo.

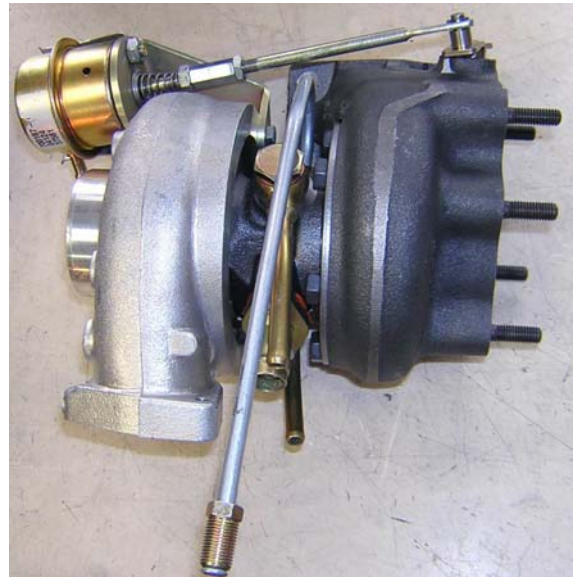
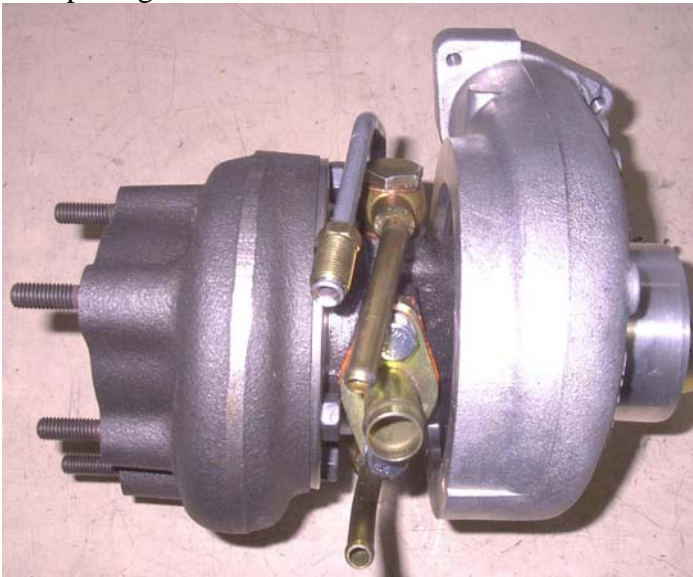

7. **Install the turbochargers** onto the installed manifolds using the supplied stainless steel gaskets and the 8 copper plated 8mm lock nuts (30-32 ft/lb). You will need to bend the motor mount shields closer to the motor mounts to clear the turbos. Move the turbos around and tilt the front of the turbos downwards slightly to find the clearance path to get them in place. Unbolt the starter for clearance while putting the right turbo and plumbing in place and rebolt it when done. On the left turbo, the wastegate arm will be close (3/16" to 1/4") to the inner fender well, but won't touch, as the engine torque is up and away. Check that this clearance is correct before tightening the turbo. A dimple in the body will increase clearance, but is normally not needed. It will be difficult to get all of the nuts started and tightened without a 12mm box wrench that is bent 90 deg. to tighten the left side turbo's forward inboard nut from between the turbo and the engine block. A wrench is included for this nut. The other forward nuts can be tightened with a good 1/4 drive 12mm swivel and a long extension. The back 4 nuts are easily tightened from the rear.

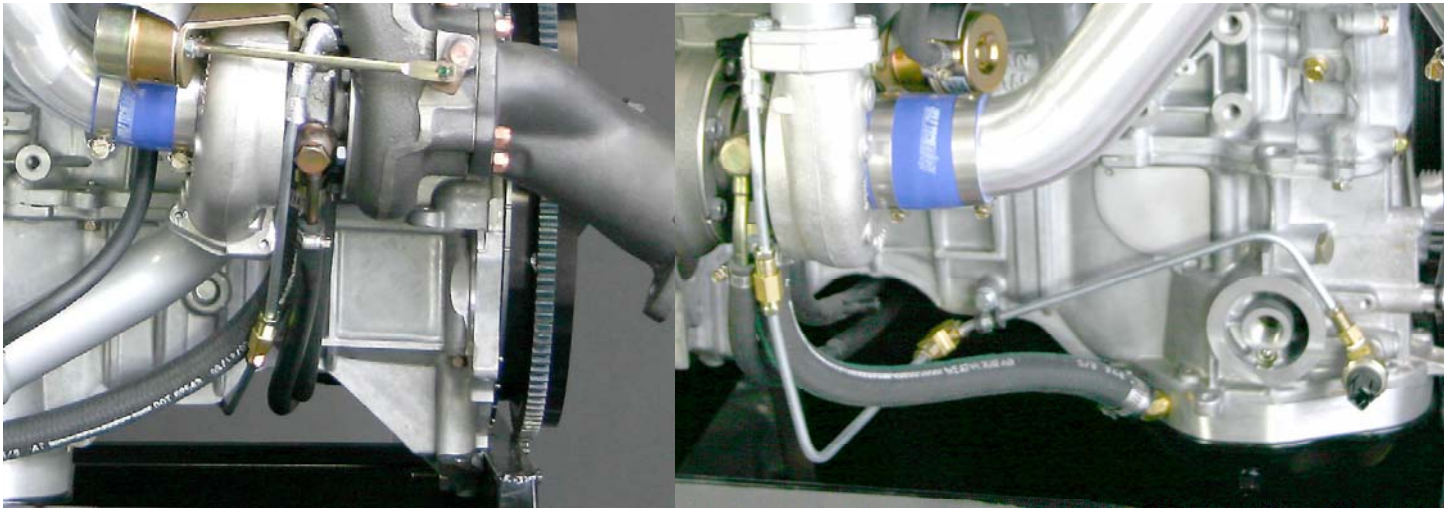

8. **Install the compressor outlet tubes** on both turbos using silicone sealant on the triangle flange (the flanges are flat surfaced and don't require gaskets) and M6 X 16mm bolts and lock washers. Check that the left outlet tube is not touching the motor mount, if so, clearance the edge of the mount slightly to clear. Both tubes have 1/4" nipples on them, the left tube nipple should be capped off (not used). On the right tube nipple, attach a 24" long piece of the supplied 1/4" rubber hose and a hose clamp. This will be routed into the battery area and connected to the FMU later.

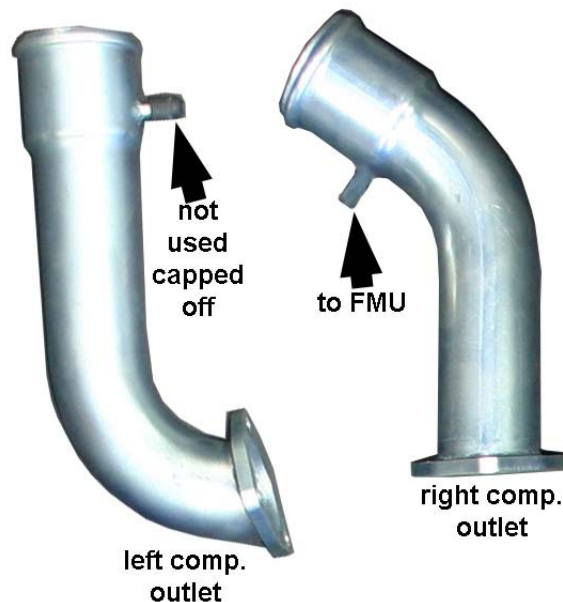

9. **Connect the wastegate actuators** with the supplied 1/4" rubber hose and hose clamps. These hoses must be Thermal wrapped starting at the hose clamps (leave an edge of the wrap under the clamp to hold it in



place) and wrapped for a length of 6" to 8" and secured with a zip tie on the other end of the Thermal wrap. These hoses should be **carefully routed downward and away from the manifolds** and then forward along the inner frame rails so they can later be connected to the intercooler outlet tee fitting up front. The left side hose must be routed down and behind the back of the AC compressor to minimize its heat exposure. **Attention to routing and heat exposure will greatly increase the reliability and safety of this installation.**

10. **Install the 5/8" heavy oil drain hoses** between the turbo drain fittings and the oil pan spacer fittings, previously installed on the pan spacer. The shorter hose goes on the right side. Twist these hoses until they

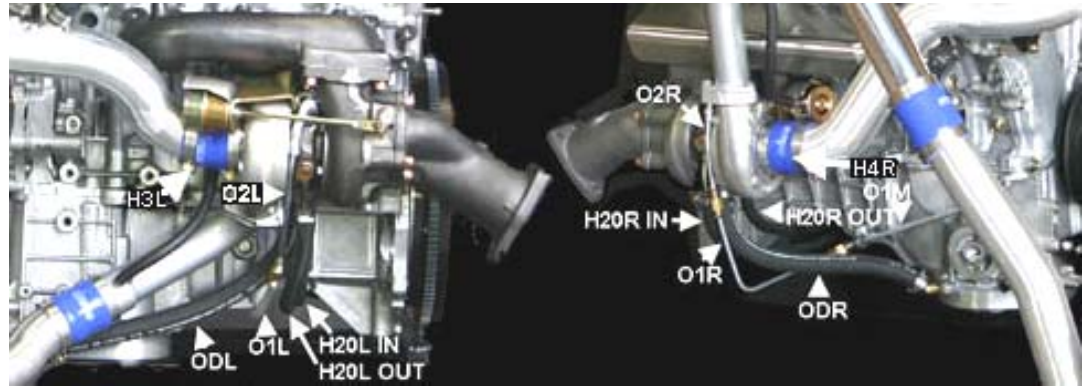

are routed without binding or touching other parts. Use the supplied #10 hose clamps on all ends. These clamps must be very snug as the hose has a steel reinforcing inside it.

11. **Connect the turbo coolant banjo fittings** to the previously install 5/16" Tees using the supplied 5/16" rubber hose and clamps. It is not important which banjo fitting is the inlet or outlet sides. Again adjust and protect the hoses from heat or rubbing against other parts. Adjust and connect the oil pressure lines to the previously installed oil pressure lines. The oil lines can be bent slightly to their final positions. Note that the coolant and oil lines must move with the motor and should not be fastened to any stationary parts like the steering rack, etc.

12. Install the (qty 5 in each turbo) long M8 studs (tighten to 6-8ft/lb) into both turbochargers' exhaust outlet flanges (use anti-seize). **Install the turbo outlet castings** onto the turbos, using the copper plated lock nuts. A thin coat of hi-temp copper silicone sealant is used on the sealing surface (no gasket is required). **Transfer the oxygen sensors** from the original manifolds to the outlet castings and reconnect them to the original plugs. Transfer the single M10x1.5 stud from each original manifold outlet flange to the same position in the new turbo outlet castings. **Drill out the threaded upper right hole in the right catalytic converter and use the supplied M10x1.25 x 35m.m. bolt in place of the original stud (this allows you to tighten it from behind the flange which is much easier).** Reinstall the catalytic converters and connect the rear O2 sensors. Check that the cat. converters' heat shield edges are not touching the body,

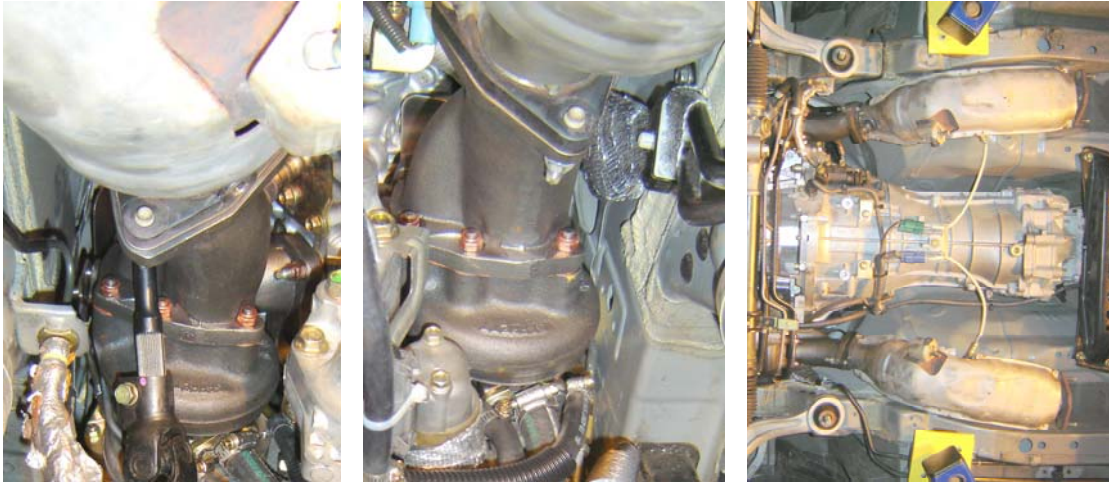

grind the edge slightly or adjust the converter to clear if needed. **Reinstall the converter support brace** between the catalytic converters. Install the rest of the exhaust system.

13. **Reinstall the steering rack** and connect the steering shaft exactly as previously marked. If the shaft has been rotated by 360 deg, it will cause the Vehicle Dynamic System to think you are in a hard turn, causing the brakes to be applied unpredictably! Use Loctite on shaft bolt. Reinstall the cross member support assembly.
14. **Install the 2.25" compressor inlet tubes** on both turbos using the supplied 2.25" blue couplings and hose clamps. Be sure to position the compressor tube hose clamps so they can be accessed later. They should be



rotated so they are accessible from under the car. **You will need to slightly and carefully bend the power steering pump tube on the right side and the AC compressor tube on the left side for clearance.** Do not allow the bends to be completely focused at the base of the tubes as this can weaken them at that point. The AC compressor mounting bolts were removed earlier to allow the left compressor

inlet tube more room for installation. Once the left compressor inlet tube is in place, (clamps are still loose) the AC compressor bolts and drive belt can be temporarily secured to accurately adjust the AC tube. At this time, check that the Thermal wrapped wastegate hose is safely routed down and behind the AC compressor and not near the exhaust manifold. The AC tube can be bent inward for added clearance between the left compressor inlet tube and the inner fender wall. Also bend the upper part of the AC tube upward to gain added clearance to the manifold heat shield.

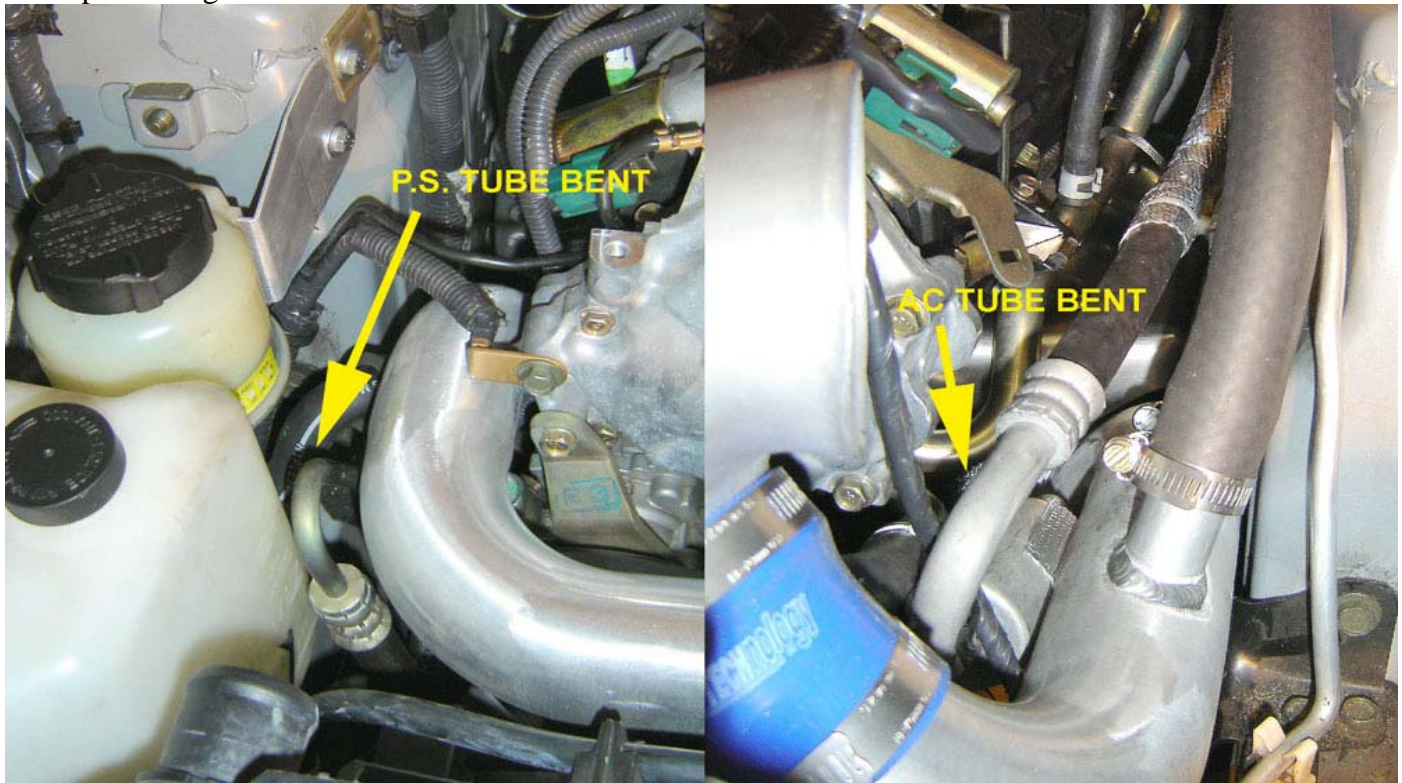

15. **Install the manifold heat shields** using the supplied stainless M6 bolts. Put a small film of anti-seize on each manifold /shield mounting boss to minimize any creaking noises during cool down. It may be a tight fit sliding the shields into place, so be careful that the heat shield edges don't cut into any other parts during this step. **Before bolting the left shield (laying loosely in place), the heater bypass tube needs to be re-installed** using the original metal gasket and silicone sealant The heater bypass tube support



bracket bolt above the left heat shield, is very tight to get started, but can be installed with a 12mm 1/4" drive swivel socket as shown. After tightening the shield bolts, adjust the shield edges slightly if needed so they will not vibrate against other parts. A good test is to "flick" an edge of each heat shield after

bolting them in, and listen for any resonating rattles from touching other parts. **Reinstall the oil dipstick guide**, and the AC compressor and belt.

16. **Install the remaining right side intermediate 2.25" compressor inlet tubes and support brackets** at the front of the engine. Attach the right side bracket to the upper cam cover bolt hole, using the supplied M6 x 25mm bolt and 3 flat shim washers to clear the cam cover and attach the remaining left bracket as shown. **Connect the aluminum intake-casting Tee** to both the left and right side 2.25" tubes as shown.



Adjust all of the tubes for clearance and tighten the clamps including the ones at the compressor inlets. All of the tubes will need to be final adjusted and retightened later when all of the parts are in place. **Reattach both ground wires** previously removed from the right front corner of the engine to their same position (adjust the larger terminal to clear the tubes) and insure that the alternator wiring loom is freely positioned between the right inner fender and the compressor inlet tube, as shown.

17. **Reinstall the main upper water pipe and upper radiator hose and all of the original rubber hoses connected to it, except the oil cooler coolant return hose.** Before attaching the **oil cooler coolant return hose** to the forward underside of this pipe, it must be installed **upside-down from it's original position**. This hose must also be **cut at the top by 1"** to bring the preformed bend in the hose closer to the



pipe to clear the compressor inlet tube. After attaching the upper end, extended the lower end of the hose using the supplied 1/2" rubber hose and the black plastic 1/2" 90 deg. coupler as shown, to clear the compressor inlet tube (it will be routed around the outside of the compressor inlet tube). Cut the 1/2" extension hose as needed to clear the compressor inlet tube, and attach the open end to the oil cooler coolant outlet. Insulate and or adjust any hoses, wires, and tubes that may come in contact with other parts or within 2" of the exhaust manifold / turbos. This will be a very busy area and should be given extra attention to avoid damage or noises due to abrasion and heat.

18. Install the power steering reservoir brackets. Reposition the P.S. reservoir using the supplied bracket as shown. This can be final adjusted after the compressor outlet tubes are all in place. Check that the reservoir hoses are not binding with other parts, and adjust and pad them as needed to avoid abrasion of the hoses.



19. Extend the PCV breather hose. Using the supplied 5/8" rubber hose and 5/8" black plastic hose coupling, extend the crankcase ventilating hose that was connected to the original throttle tube. Connect the extended hose to the 5/8" nipple on the left compressor inlet tube directly behind the recirculation valve hose. The breather hose should be long enough to be routed away from the 3" throttle tube and any

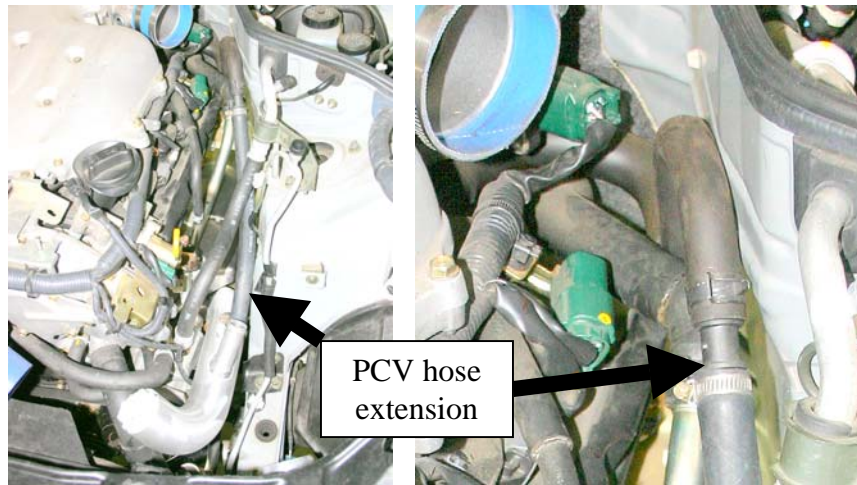

other parts including the inner fender. Thermal wrap this hose and the AC hoses as needed, if they are within 2" of the manifold.

20. Install the recirculation valve. Install the supplied 3" aluminum throttle tube using the blue 3" hose

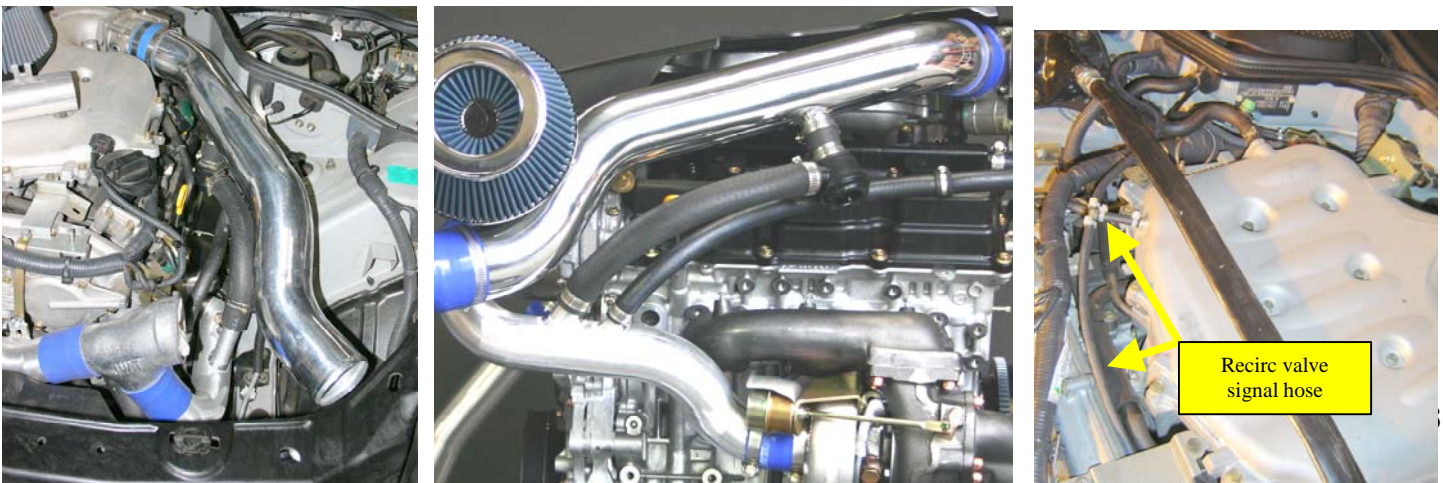

coupling and clamps. Clamp it at the throttle side only for now. Slide the tube all the way into the coupling until it touches the throttle for initial positioning. Cut a 2" long piece of the supplied 1" rubber hose and couple the end of the recirculation valve that is opposite the small signal line nipple to the 3" tube, the other 1" recirculation valve nipple should be pointed forward. With the 3" tube in place, measure and cut the remaining 1" rubber hose to go between the open nipple on the recirculation valve and the 1" nipple on the left compressor inlet tube below and forward of it. Check to insure that the 1" hose is not kinked before clamping it in place using the supplied #20 hose clamps. Attach the supplied 5/32" rubber hose to the small nipple on the recirculation valve and use a Zip tie as a hose clamp and thermal wrap the first 6" from the recirculation valve. Route this hose up to the front of the intake manifold and connect it to the existing manifold nipple as shown (shown with a boost gauge signal line Tee'd into it). Use zip ties on the ends of all of the hoses.

21. Mount the intercoolers (IC): Unpack and inspect the new intercooler for foreign material that may have



entered the end tanks. Using the supplied M10 x 60mm bolt and washers, loosely hang the intercooler from the center support on the bumper as shown. Align the intercooler so that the outer end tanks are an equal distance from the radiator core support and clear the bumper brackets. You may need to remove or grind one of the lower bumper bracket bolts at the core support if it touches the end tanks. This is a tight area and will not clear if the car has crash damage that is not properly repaired to factory specifications. Attach the outer intercooler mounting brackets to the intercooler and mark and drill the bolt holes in the bumper so the outer brackets maintain the tank to core support clearance. Install outer mounting bracket bolts and nuts to the bumper and tighten all 4 outer bolts first, then the center support bolt last.

22. If car is equipped with a power steering cooler, reposition it by bending and repositioning the cooler bracket and bolting it to the bottom of the core support as shown.

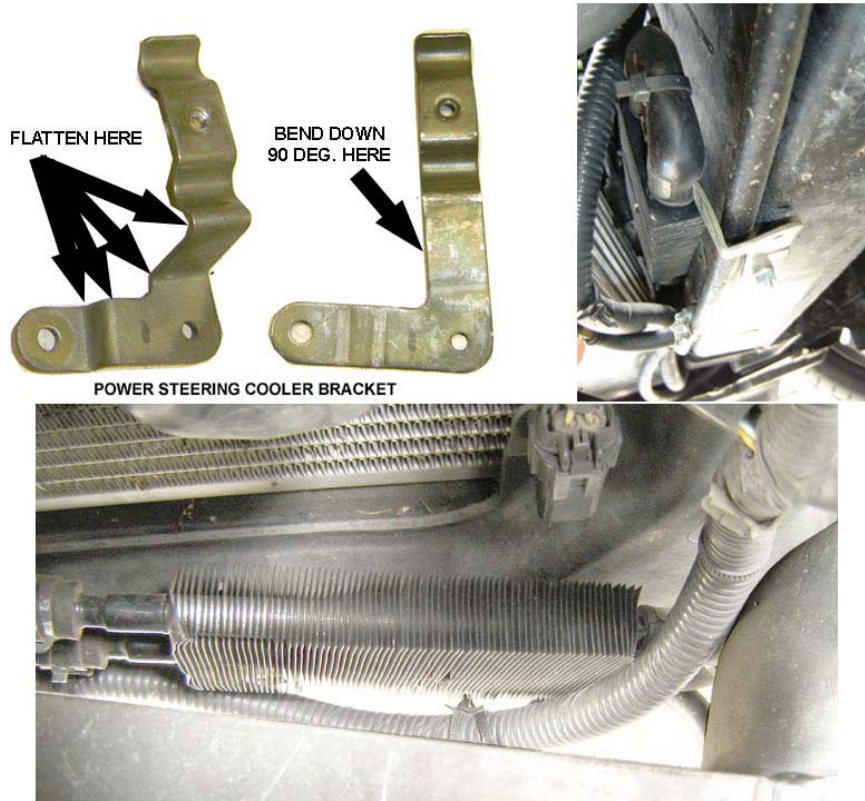

23. **Install the remaining 2" aluminum tubes** between the compressor outlets and the ICs using the 2" blue coupling hoses and hose clamps as shown. Some of the blue couplings are extra long to be used where extra adjustment might be needed. Be sure that all hose clamps are positioned to easily retighten them after all parts are installed. Trim the lower left vertical plastic air shield as needed to clear the left side 2" IC tube routed from the left turbo to the intercooler. This is easily done with scissors. Also cut a 6" by 6" opening in the horizontal plastic shield below the left front fender for additional cold air to reach the air filter. On the right side, adjust the power steering hoses as needed as the 2" tube (6RZ) passes them upward. Remove the plastic brake line to inner fender support that is next to the upper tube (5RZ) coupling hose for clearance.

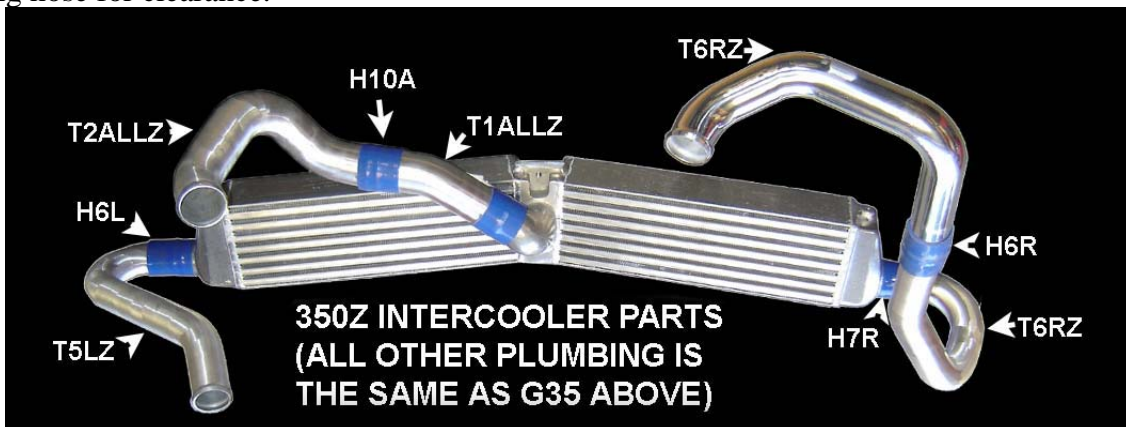

24. **Install the supplied windshield washer reservoir.** Carefully remove the washer pump(s) and grommet(s) from the original reservoir and install them into the new reservoir as shown. Attach the reservoir to the core support with the supplied clamp as shown. Cut the original plastic filler tube and connect it to the supplied rubber 5/8" fill hose, using the supplied 1.25" shrink tubing (using a heat gun). With the filler top in place, route the 5/8" hose to the reservoir nipple without any kinks and attach it with



a hose clamp. Attach the 1/4" overflow hose to the reservoir nipple and loop it up and then down towards the ground as shown. Attach the original water hose and electric plug to the pump and adjust the reservoir and pump so it does not touch other parts. The fluid level sensor is not used and the elec. Connector is left unplugged (the light remains out when unplugged). Fill with windshield fluid. If you have an additional rear window pump and want to maintain it's use, you will need to drill an additional hole (23/32") in the reservoir next to the existing pump hole.

25. **Connect the 2.5" I.C. outlet tube (1ALLZ) to the intercooler exit. Install the remaining 2.5" tube (2ALLZ) through original air intake hole in the core support and connect it on the lower end to the 2.5" I.C. outlet tube and the 3" throttle tube on the top end using the supplied 2.5" to 3" blue adaptor hose coupling and clamps. Place the supplied 1" long edge pads on the edges of the core support where the tube will touch. This 2.5" curved tube will only fit if it is installed in the correct direction, if it doesn't fit, try turning it around. This will be another busy area that will require some adjustment on each hose and tube until the entire system is not touching other parts. Some padding between parts may be needed if this is not possible.**



26. **Trim the original body air filter support bracket protruding from the strut tower, and the body brace to clear the new air filter as shown (cover the engine compartment area while cutting). Install the MAF sensor onto the air filter aluminum funnel. Install the heat shields and heat shield seals as shown (use the plastic snap rivet from the original air snorkel). Install this assembly onto the previously**



installed aluminum intake Tee casting using a blue 80mm hose coupling and clamps. Loosen and adjust all of the tubes until the MAF sensor and filter assembly is angled low enough to allow the hood to clear without touching the filter element when it is closed. **Be sure to reconnect the MAF sensor electrical plug** once the sensor is permanently in place. Adjust the shield seals for the best seal against engine compartment heat.

27. **Fill the engine with synthetic engine oil and a new oil filter.** Remember to add 1 additional quart since the oil pan spacer is now in place. **Reinstall the coolant recovery tank and hose. Fill the engine with coolant.** You must open the bleed port on the heater hose behind the engine, and fill until solid coolant is present. Let the coolant settle for 5 min. and repeat this several times (burp the system by slowly squeezing the upper rad. hose between filling). If all of the air is not removed, the engine can over heat.
28. **Trim the lower grill fin as shown** to clear the intercooler. Test fit the body nose onto the car and check for any interference between the nose and any parts, adjust the parts as needed. **Reinstall the body nose.**



29. **Final check that all tubes, hoses, and wires are adjusted** so they don't contact other parts and that all of the hose clamps and brackets are tight. Double check that all Thermal wrap is correctly installed and fastened on all wires and hoses that are 2" or closer to any heat source. Please reread the steps up to this point and recheck your work for any omissions or problems. Where all of your protective tube end coverings **actually** removed during assembly? **Reinstall the plastic engine shroud** on top of the engine. A small edge on the left front of the plastic engine shroud needs to be trimmed to clear the intake casting.
30. **Installing the new fuel pump and FMU. See separate Fuel Management Unit installation addendum.**
31. **Install the Spark Timing Unit (STU): See separate Spark Timing Unit installation addendum.**
32. **Install the fuel pump controller and FMU signal controller, (if used): See separat addendum, if used.**
33. **Reconnect the battery ground cable to the battery, but leave the ECU disconnected.** This is a good point to get oil pressure to the turbos, since the ECU is disconnected and won't energize the fuel pump or the injectors during cranking. Crank the engine until the oil pressure light goes out and continue another 30 seconds to insure oil has filled the turbo oiling system. Again remove the ground cable from the battery. Check the entire system for oil and coolant leaks. Reconnect the ECU connector. Again check the installation for anything that needs correcting before initial start up.

34. **Install a temporary fuel pressure gauge and an intake manifold boost pressure gauge (1/2PSI or better resolution)** to determine if the installation is operating as expected during initial testing of the vehicle. The maximum sustained boost pressure should be 6.8 PSI at the intake manifold. Fuel pressure should be 52 PSI up to 2 PSI on the boost gauge and fuel pressure should rise 3.5 to 4 PSI for each PSI of boost (the FMU is adding pressure to compensate for the additional manifold pressure and for fuel enrichment). Again check the entire installation for loose bolts, hose clamps, or parts that are not properly heat shielded, and any other condition that should be corrected before starting the engine. Any questions about this installation that you have should be answered before you continue. **You can contact Jim Wolf Technology, Inc. at 619 442-0680 Mon.-Fri. 8am-5pm PST or email support@jimwolftechnology.com .**
35. **Initial startup:** Turn the key to ON and confirm that the fuel pump turns on for 2 seconds and fuel pressure goes up. Confirm that there are no fuel leaks before proceeding. **Start the engine** and warm it up to normal operating temperature. Confirm that the coolant temperature stabilizes and does not climb beyond normal. If it does, you may still have air in the cooling system. Let the engine cool off and again open the bleed port on the heater hose to bleed the rest of the air out while topping off the radiator. **Check the oil level in the engine before driving.** Check for any fluid leaks around the turbo fittings, hoses, and the rest of the engine before test-driving.
36. **Initial test drive:** With an observer in the passenger seat, drive the car for a few miles (no boost) near the shop, so adjustments can be easily made, if needed. Stop and open the hood a few times and inspect for any conditions that need to be fix. If all is well, in a safe area with no other traffic, slowly open the throttle into the boosted mode by loading a little at a time until 2-3 PSI is seen on the boost gauge. Confirm the fuel pressure rises as described previously (the fuel gauge is typically taped to the outside of the windshield for testing) and that the engine pulls smoothly with no pinging or detonation. If all is OK, again load the engine a little more, pushing the boost to 3 to 4 PSI and observe that all is OK. If all is OK, carefully load the engine to full boost, immediately backing off the throttle if the boost exceeds 7.5 PSI or detonation occurs. **If either condition occurs, or you are not familiar with the audible sound of detonation, please contact the support department before continuing.**
37. Return to the shop and check the positions of all the tubes and thermal wrap and retighten all of the hose clamps, as they will loosen slightly during the initial test run. Also check and fix any other problems and install the remaining air shields under the car. Continue to drive the car and monitor all systems until you can confirm that the system is operates safely without detonation. If the fuel and boost pressures are correct, remove the temporary fuel gauge.
38. **Remember that this is now a turbocharged, high compression engine which must be operated on absolutely no less than 91+ octane gasoline for typical street operation and no less than 100+octane unleaded on the track or during any extended wide open throttle operation. Octane booster can be temporarily added if pinging occurs during ambient air temperatures above 85F, but boost should be limited until the air temperature is below 85F. Driving under extreme conditions that can cause excessive oil and coolant temperatures, will require larger capacity oil and coolant cooling systems be installed. Maximum boost must be limited to no more than 7.5 PSI. If any condition exists that is causing ping or detonation during boost, do not operate the vehicle in boost until this condition is fixed or damage to the engine can occur! All persons driving this vehicle must be made aware of these requirements.**



JWT G35 / 350Z TWIN TURBO FUEL MANAGEMENT UNIT (FMU) INSTALLATION GUIDE ADDENDUM



1. **Installing the new fuel pump and FMU. Wear eye protection and insure that you are working in a well-ventilated area without open flames, static electricity or spark potentials, as gasoline fumes will be present.**
2. **Installing the 1/8" nylon FMU signal line.** Remove all of the battery compartment covers so you can see the ECU wiring grommet in the firewall. Connect the supplied 1/4" rubber hose & clamp to the nipple on the right compressor outlet pipe (if not all ready connected earlier) and route it into the battery compartment by cutting a hole in the rubber battery cable grommet next

BRING THE FMU SIGNAL TUBING INTO THE PASSINGER COMPARTMENT THROUGH THE ECU WIRING GROMMET.

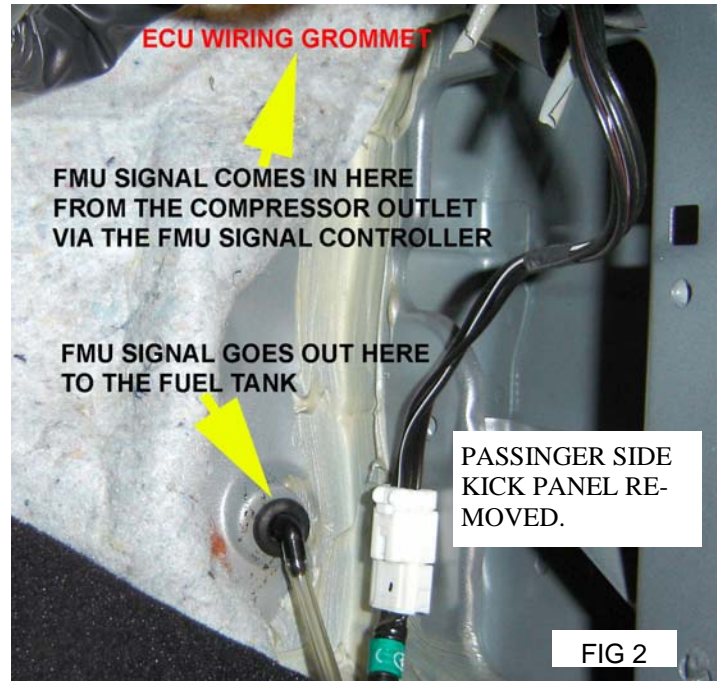
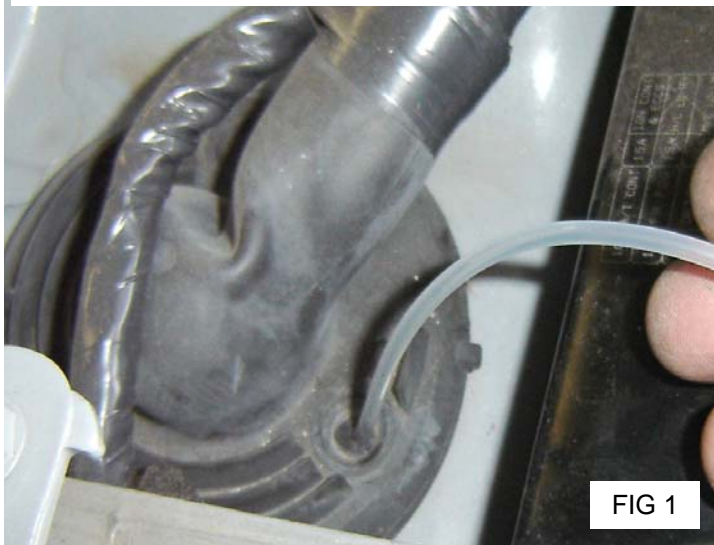

to the battery cable. Connect the 1/4" plastic fitting on the end of the supplied 1/8" nylon tubing into the 1/4" rubber hose and use a zip tie to clamp it. Using a welding rod or coat hanger, poke a hole in the outer diameter of the grommet as shown (**fig. 1**) and carefully bush the rod into the passenger compartment. Care must be taken to avoid poking into the actual wires. Once the rod is seen in the passenger compartment, attach the nylon tubing to it's end and pull it through the grommet into the passenger compartment leaving enough tubing in the battery compartment so

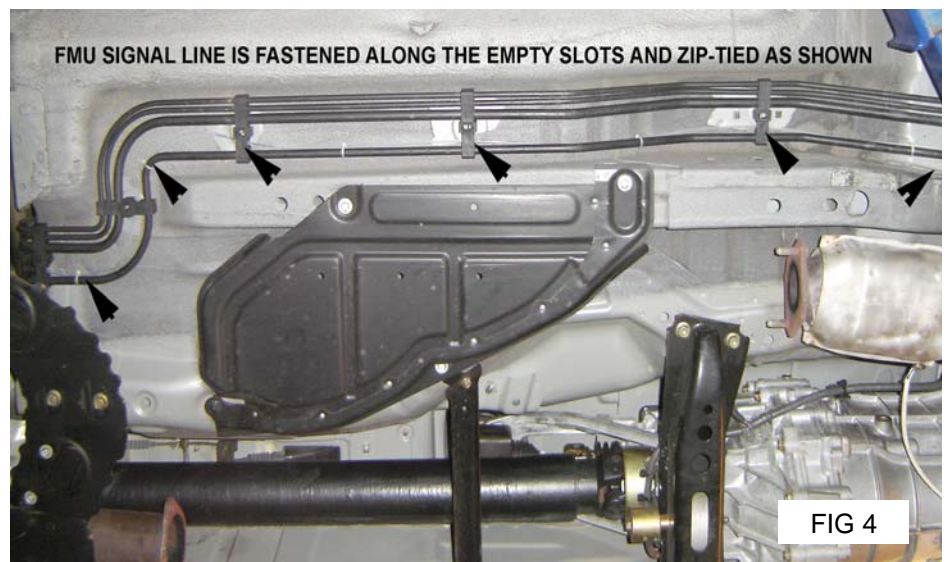

it has a relaxed routing. Do not kink the tubing!. Open the rear section of the right front wheel well plastic liner and the inside kick panel and **route the remaining 1/8" tubing out though the existing body grommet (drill a small hole through the grommet).** (Fig. 2&3) This grommet is for the rear window washer hose on the 350Z, if so equipped. Continue fastening the signal tube along side the fuel line mounting brackets back to the fuel tank using zip ties to secure it. **The open end will be connected later.**

3. Remove the (G35 rear seat cushion) (350Z storage compartment floor panel) and the right side (again, this is always from the drivers perspective) fuel tank access cover.
4. Release the fuel line using a rag to cover the connection, as residual pressure may still be present. Unplug the electrical connector and unbolt the tank unit-retaining ring. Lift the pump / sending unit assembly out of the tank just far enough to disconnect the sub tank's jet pump hose on the side of the assembly. Remove the assembly and place it in a tray to confine the

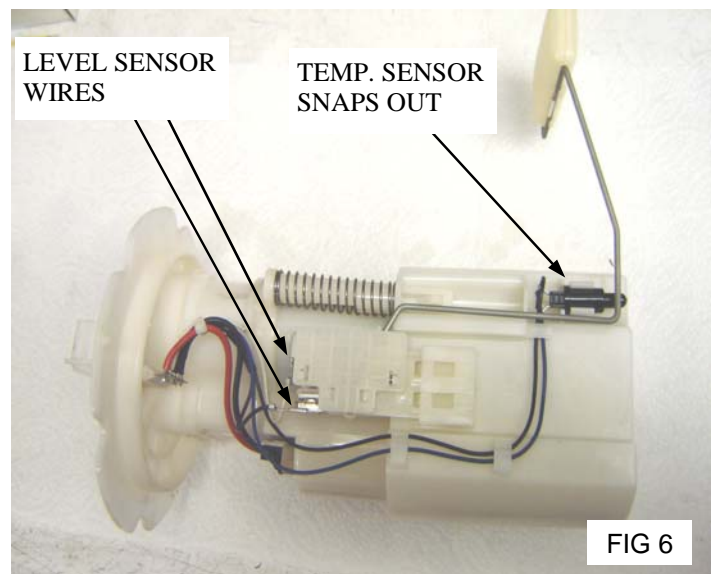
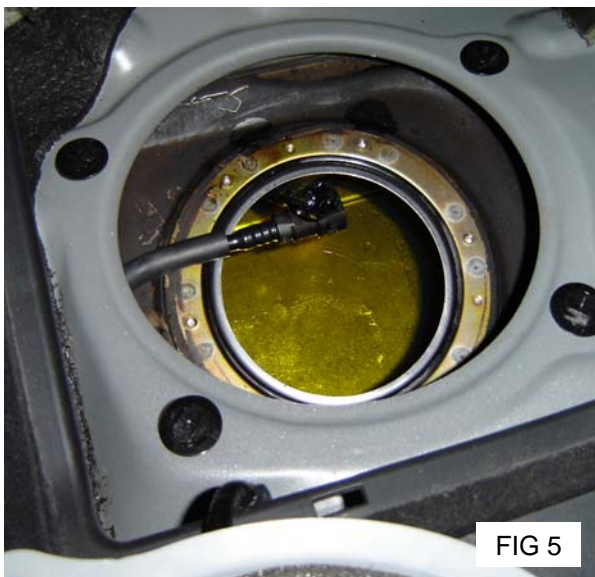

gasoline that will spill from it. Temporarily cover the hole in the tank. **FIGURE 5**

5. Disconnect the level sensor wires (note which pins you removed them from) and unhook the temp sensor. **FIGURE 6**
6. Pull the white plastic lock tabs away from the assembly body and release the lower half. Remove the original fuel pump by carefully removing the plastic retainer cage and the 2-wire plug on the top of the pump. **FIGURE 7**

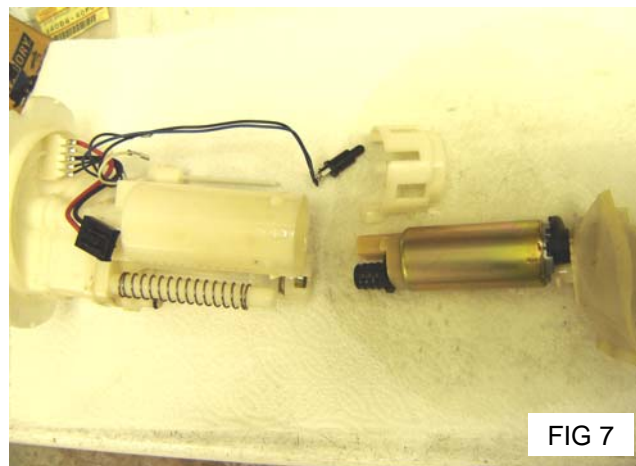

7. Mark the spot to drill a hole for the bulkhead fitting as shown and **cut or scrape any plastic ribs away on the underside of the assembly, so that the nut will sit flush against the surface.** Start with a smaller drill bit and step up to the final size to avoid cracking the plastic. **Using the final drill size of 25/64, drill a hole exactly as shown for the bulkhead fitting to pass through.** This fitting must be installed from the outside, with the retaining nut inside the tank to insure a proper seal (the seal is against the smooth outside surface). Install the supplied bulkhead fitting. **FIGURES 8 AND 9**

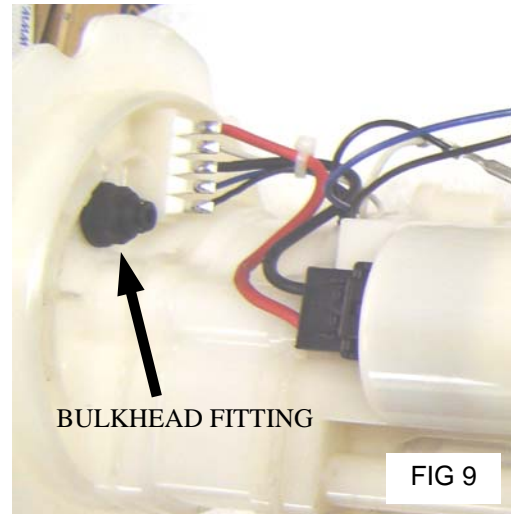
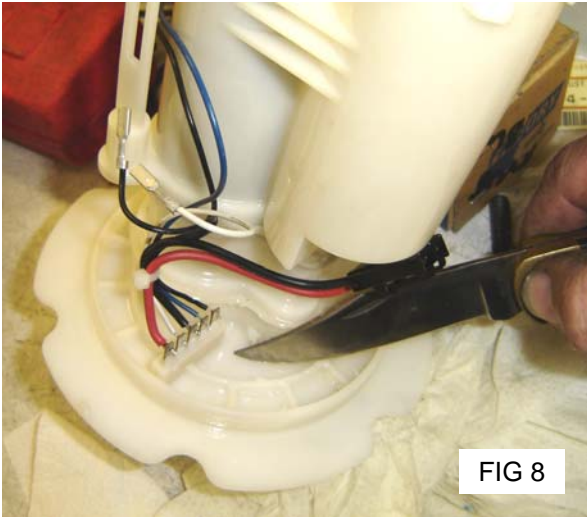

8. Transfer the original pump outlet seal and inlet strainer to the new pump. The strainer retaining clip can be removed by using a knife blade under it to pry up a little at a time on each side. **Because the new pump is slightly longer than the original pump, you will not reuse the black rubber pad from the old pump and you will need to cut off the plastic tabs on the bottom of the new pump with your diagonal wire cutters.** Install the new pump into the assembly and carefully reinstall the retaining cage around the end of the pump. Connect the electrical connector to the new pump. **FIGURES 10, 11, 12**



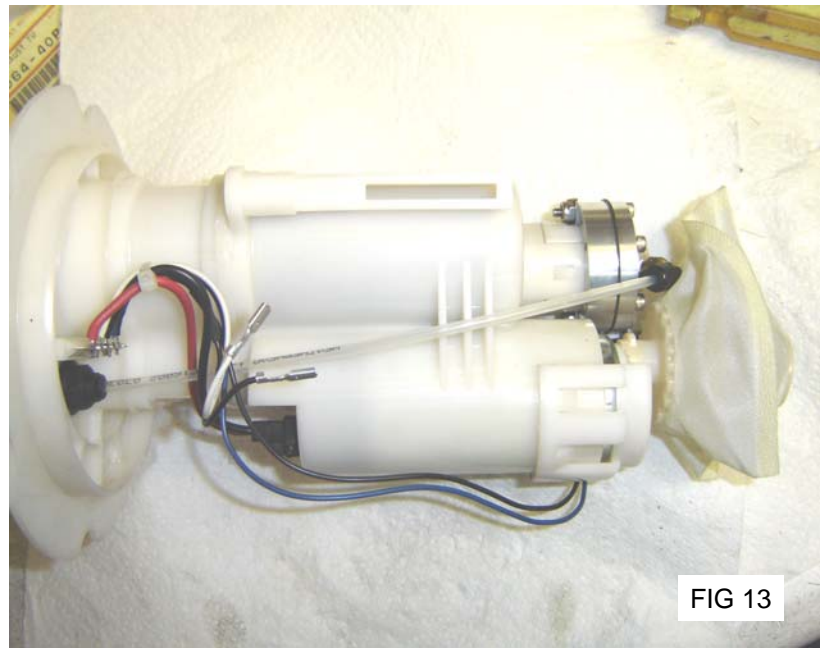

9. **Install the new FMU on top of the stock fuel regulator** by first sliding the 3 holed FMU support bracket through the plastic regulator retaining cap. (**Fig. 12**) Check that the direction of the FMU signal port is pointing in the direction of the bulkhead fitting. Carefully seat the FMU in place with the 2 long studs engaging the bracket. Tighten the retaining nuts a little at a time checking that the FMU remains seated correctly on the regulator. **Route a section of 1/8" nylon tubing in a smooth arc from the FMU to the bulkhead fitting** as shown. The 1/8" nylon tubing ends must be cut strait across with no burrs before inserting. (Note: If you need to release the tubing from the fitting, push down on the ring around the tube and pull it out.). **FIGURES 13**
10. **On the lower assembly section you removed earlier, cut away the inside baffle wall as shown**, so that the new FMU will clear when you reassemble it. This can be done by nibbling a **little at a time** with diagonal wire cutters. Completely remove all debris from the parts. **FIGURES 14 AND 15**

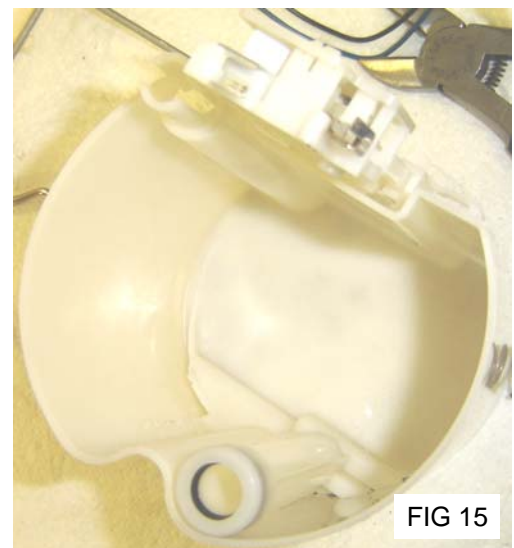
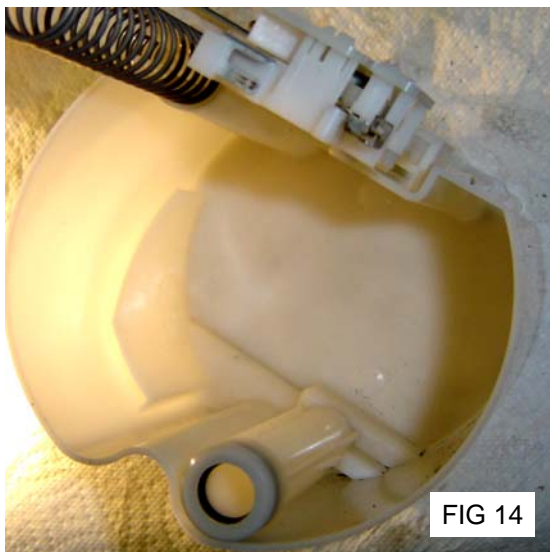

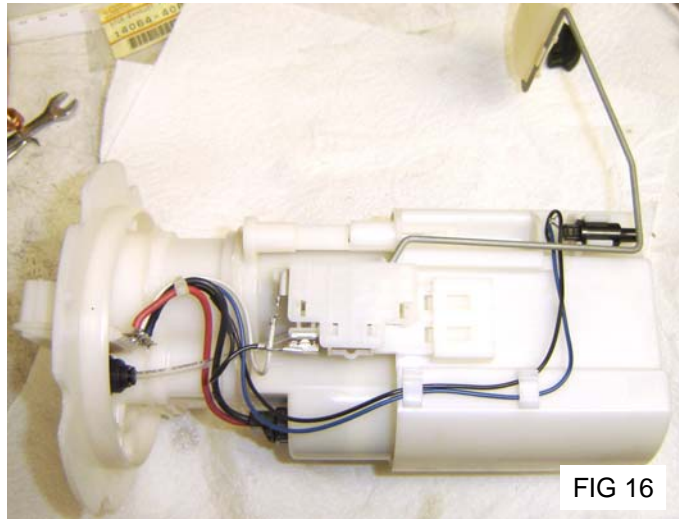

FIG 16

11. Reassemble the pump / sending unit assembly. **FIGURE 16**
12. **Look carefully for any damaged or unplugged parts before installing the assembly into the gas tank. Replace the old O-ring with a new one (Nissan # 17342-01A00 if not provided in kit). Insure that the tank O-ring seal is correctly placed in it's groove before bolting the assembly in place. If this O-ring is not correctly seated, gasoline can leak causing a fire hazard. Install the assembly into the gas tank. Be sure to reconnect the sub-tank tube to the assembly as it is going back in. FIGURE 5 & 17**

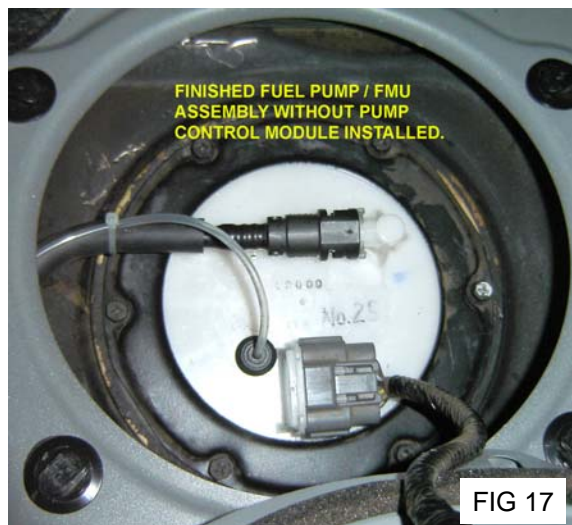
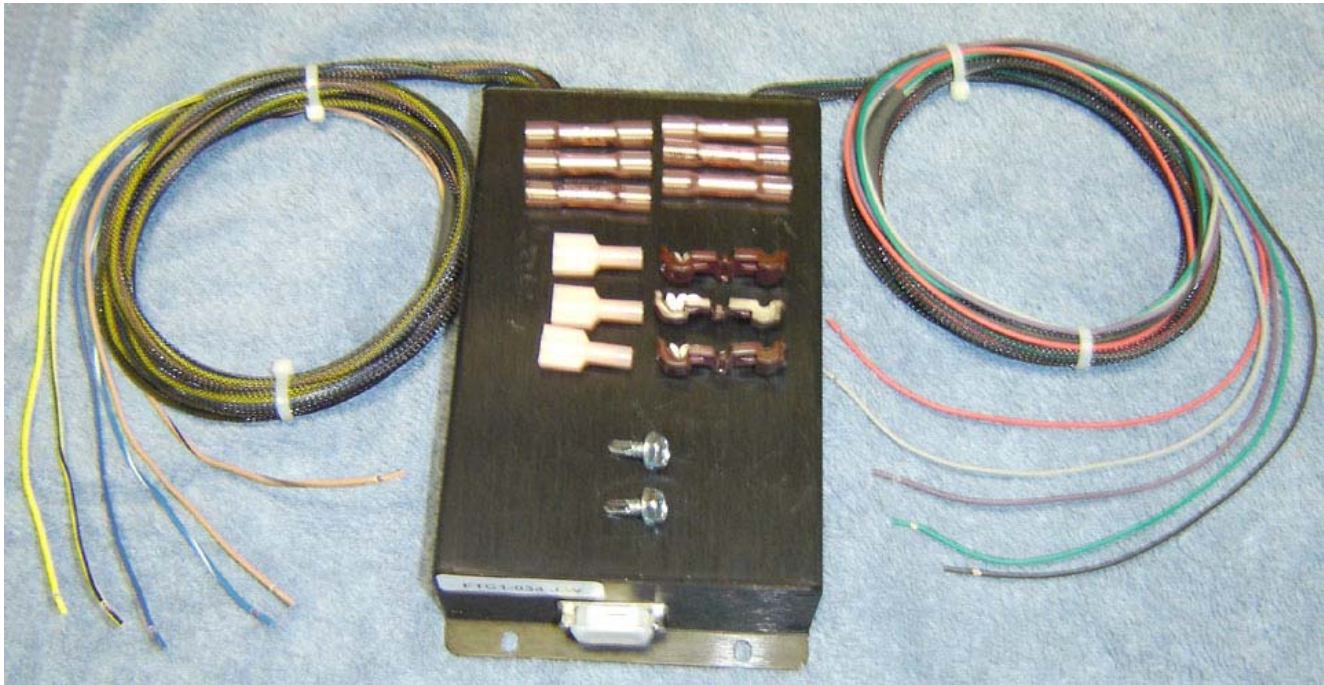

FIG 17

NOTE: This picture does not show a fuel pump control module signal tee'd into the 1/8" nylon tube. A Tee will be spliced in later if a fuel pump control module is used.

13. **Connect the fuel line and electrical plug. Connect the 1/8" nylon signal tube to the bulkhead fitting with a large smooth arc that won't kink or rub against other parts. Secure the 1/8" nylon tubing with a final zip tie to the fuel line, just back of the smooth arc into the bulkhead fitting. FIGURE 17**

JWT G35 / 350Z TWIN TURBO SPARK TIMING UNIT (STU) INSTALLATION GUIDE ADDENDUM



1. Remove the engine control unit (ECU) harness connector from the ECU (**the actual ECU does not need to be removed**) under the right side dashboard. Remove the passenger side kick panel (the plastic panel forward of the right side lower door hinge).
2. Discard the wire cover on the back of the connector and untape the harness covering by 6".

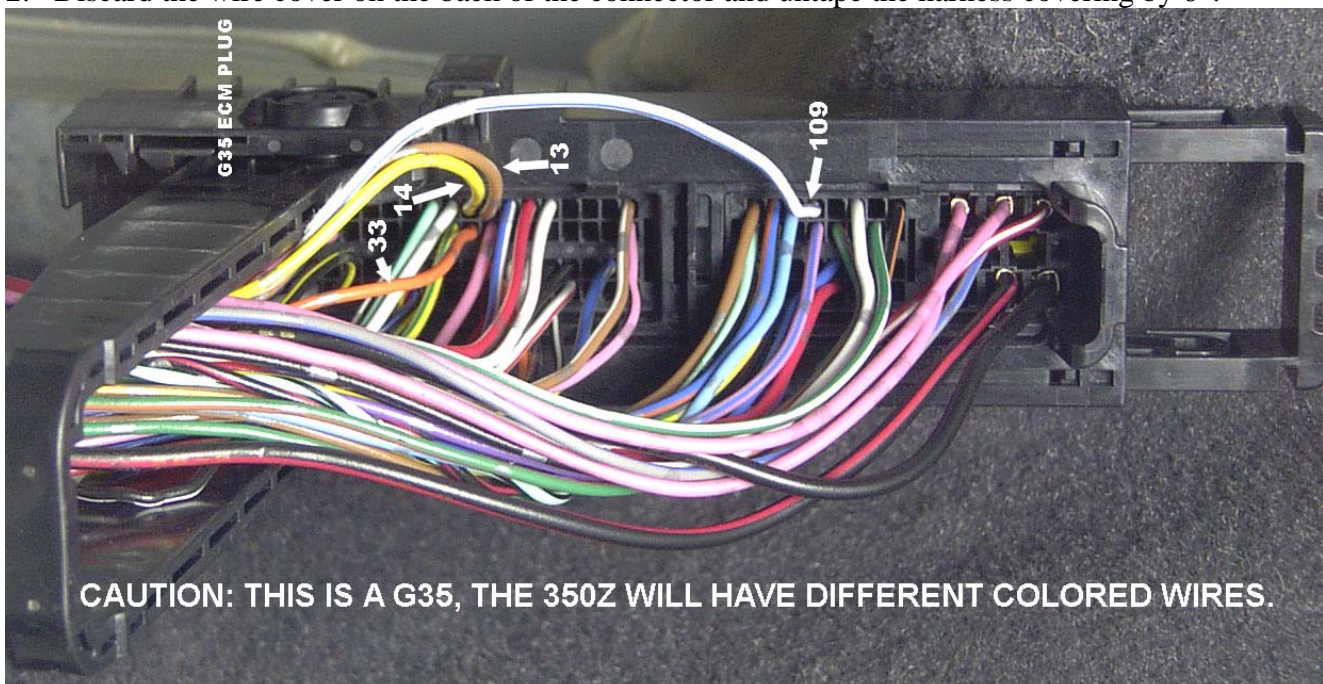

- Using the wiring diagram below, identify and label each of the wires to be cut or tapped in the ECU wiring harness. Confirm that all pin locations and wire colors are the same as the diagram before proceeding. **Damage to the control system will occur if the wires are incorrectly connected!**

JWT TWIN TURBO SPARK TIMING UNIT (STU) WIRING DIAGRAM

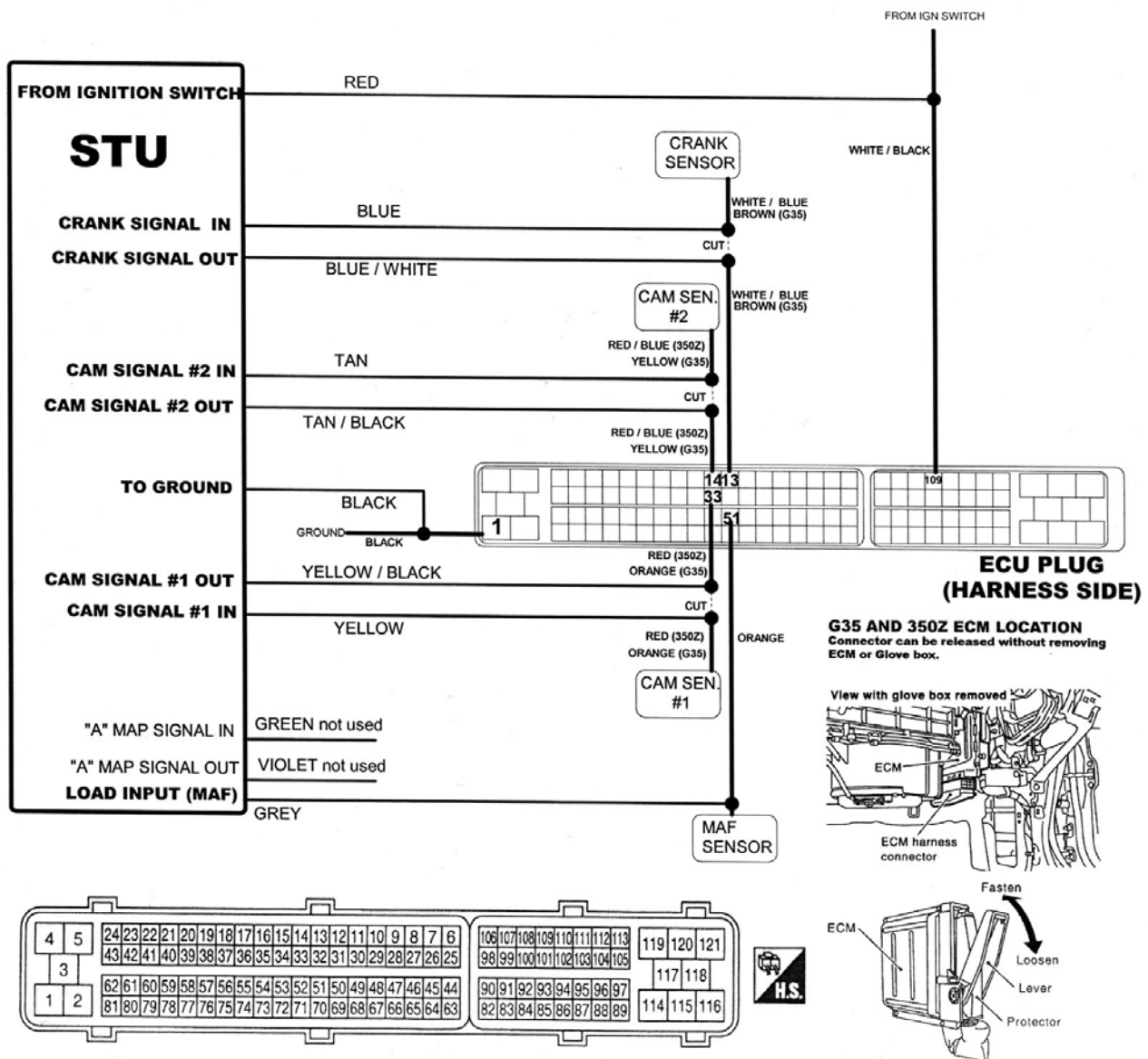

- Following the diagram, cut one of the 3 cam / crank sensor wires at a time at least 4" away from the connector. Using a professional grade terminal crimp tool, connect each end of the cut wire to the correct STU wire using the provided red butt connectors*. Be sure you are connecting the correct ends of the cut wires to the proper STU wires.
- Crimp the provided male spade terminals to the 3 STU wires (see diagram) that you will be **tapping** into the ECU wires. Identify the ECU wires being tapped into, and install the provided taps onto each wire. Connect the STU wires to the correct taps on the ECU wires.
- Secure the STU inside of the passenger side kick panel. Insure that the wires are not rubbing other parts and replace the kick panel.

* Optionally, the installer may solder and shrink tube these connections.

NOTE: This STU is programmed for typical street use. If reprogramming is needed, contact JWT for more information.

JWT PART#	PART DESC	QTYZ	CATEGORY	BOX	SUB PACKAGING
AF-Z01-APC	AIR FILTER, 3.5" POPCHARGER	1	AIR FILTER	MM	AIR FILT H/SHIELD TRIM KIT
AF-Z02-SHSTRP	SHIELD, AIR FILTER TOP STRIP ALUM.	1	AIR FILTER	MM	AIR FILT H/SHIELD TRIM KIT
AF-Z03-SHMAIN	SHIELD, AIR FILTER MAIN ALUM.	1	AIR FILTER	MM	SEPARATE
AF-Z04-SHTOX11	SHIELD, AIR FILTER TRIM EDGE "E"	1	AIR FILTER	MM	AIR FILT H/SHIELD TRIM KIT
AF-Z05-SHT3X54	SHIELD, AIR FILTER TRIM 3" FLAP	4.45	AIR FILTER	MM	AIR FILT H/SHIELD TRIM KIT
ASP-G01-B6X16	BOLT, M6X16MM COMP OUTLET	6	AIR SUPPLY PLUMBING	MM	AIR TUBE HW KIT
ASP-G03-B6X20	BOLT, M6X20MM TUBE TO ENG BRACKET	3	AIR SUPPLY PLUMBING	MM	AIR TUBE HW KIT
ASP-G04-B6X25	BOLT, M6X25MM TUBE BRAC. TO RT CAM COV.	1	AIR SUPPLY PLUMBING	MM	AIR TUBE HW KIT
ASP-G08-BRT2R	BRACKET, LEFT TUBE T2R TO ENG	1	AIR SUPPLY PLUMBING	MM	AIR TUBE HW KIT
ASP-G09-BRT3R	BRACKET, RIGHT TUBE T3R TO ENG	1	AIR SUPPLY PLUMBING	MM	AIR TUBE HW KIT
ASP-GZ01-CL32	CLAMP, #32 2" TUBES	12	AIR SUPPLY PLUMBING	MM	AIR HOSE CLAMP KIT
ASP-GZ02-CL36	CLAMP, #36 2.5 & 2.25 TUBES	15	AIR SUPPLY PLUMBING	MM	AIR HOSE CLAMP KIT
ASP-GZ03-CL48	CLAMP, #48 3" TUBES	5	AIR SUPPLY PLUMBING	MM	AIR HOSE CLAMP KIT
ASP-GZ04-T2L	TUBES, T2L 2.25 DIA.	1	AIR SUPPLY PLUMBING	AT	SEPARATE
ASP-GZ05-T2R	TUBES, T2R 2.25 DIA.	1	AIR SUPPLY PLUMBING	AT	SEPARATE
ASP-GZ06-T3A	TUBES, T3A 3 DIA.	1	AIR SUPPLY PLUMBING	AT	SEPARATE
ASP-GZ07-T3L	TUBES, T3L 1.75 / 2 OUT DIA.	1	AIR SUPPLY PLUMBING	AT	SEPARATE
ASP-GZ08-T3R	TUBES, T3R 2.25 DIA.	1	AIR SUPPLY PLUMBING	AT	SEPARATE
ASP-GZ09-T4L	TUBES, T4L 2 DIA.	1	AIR SUPPLY PLUMBING	AT	SEPARATE
ASP-GZ10-T4R	TUBES, T4R 1.75 / 2 OUT DIA.	1	AIR SUPPLY PLUMBING	AT	SEPARATE
ASP-GZ11-H10A	HOSE, CPLNG H10A 2.5	1	AIR SUPPLY PLUMBING	MM	AIR TUBE HOSE KIT
ASP-GZ12-H11A	HOSE, CPLNG H11A 2.5 TO 3 X 4" OAL	1	AIR SUPPLY PLUMBING	MM	AIR TUBE HOSE KIT
ASP-GZ13-H12A	HOSE, CPLNG H12A 3	1	AIR SUPPLY PLUMBING	MM	AIR TUBE HOSE KIT
ASP-GZ14-H1A	HOSE, CPLNG H1A 80MM X 17/8" OR 2.5" OAL	1	AIR SUPPLY PLUMBING	MM	AIR TUBE HOSE KIT
ASP-GZ15-H2L	HOSE, CPLNG H2L 2.25	1	AIR SUPPLY PLUMBING	MM	AIR TUBE HOSE KIT
ASP-GZ16-H2R	HOSE, CPLNG H2R 2.25	1	AIR SUPPLY PLUMBING	MM	AIR TUBE HOSE KIT
ASP-GZ17-H3L	HOSE, CPLNG H3L 2.25	1	AIR SUPPLY PLUMBING	MM	AIR TUBE HOSE KIT
ASP-GZ18-H3R	HOSE, CPLNG H3R 2.25	1	AIR SUPPLY PLUMBING	MM	AIR TUBE HOSE KIT
ASP-GZ19-H4L	HOSE, CPLNG H4L 2X3L OR 2.5L	1	AIR SUPPLY PLUMBING	MM	AIR TUBE HOSE KIT
ASP-GZ20-H4R	HOSE, CPLNG H4R 2.25	1	AIR SUPPLY PLUMBING	MM	AIR TUBE HOSE KIT
ASP-GZ21-H5L	HOSE, CPLNG H5L 2X3L OR 2.5L	1	AIR SUPPLY PLUMBING	MM	AIR TUBE HOSE KIT
ASP-GZ22-H5R	HOSE, CPLNG H5R 2 X3L	1	AIR SUPPLY PLUMBING	MM	AIR TUBE HOSE KIT
ASP-GZ23-H6L	HOSE, CPLNG H6L 2X3L OR 2.5L	1	AIR SUPPLY PLUMBING	MM	AIR TUBE HOSE KIT
ASP-GZ24-H6R	HOSE, CPLNG H6R 2 X 3L	1	AIR SUPPLY PLUMBING	MM	AIR TUBE HOSE KIT
ASP-GZ26-H8R	HOSE, CPLNG H8R 2X3L OR 2.5L	1	AIR SUPPLY PLUMBING	MM	AIR TUBE HOSE KIT
ASP-GZ27-H9A	HOSE, CPLNG H9A 2.5	1	AIR SUPPLY PLUMBING	MM	AIR TUBE HOSE KIT
ASP-GZ28-W6L	WASHER, M6 LOCK COMP OUTLET	6	AIR SUPPLY PLUMBING	MM	AIR TUBE HW KIT
ASP-GZ29-W6BDY	WASHER, M6 BODY BRACKET TO TUBE	4	AIR SUPPLY PLUMBING	MM	AIR TUBE HW KIT
ASP-GZ30-W6L	WASHER, M6 LOCK BRAC TO ENG	2	AIR SUPPLY PLUMBING	MM	AIR TUBE HW KIT
ASP-GZ31-W6F	WASHER, M6 FLAT SPACER RT BRAC TO ENG	3	AIR SUPPLY PLUMBING	MM	AIR TUBE HW KIT
ASP-Z01-CCT1Z	CASTING, MAF TEE, T1 350Z VERSION	1	AIR SUPPLY PLUMBING	MM	SEPARATE
ASP-Z02-T1ALLZ	TUBES, T1ALLZ 2.5 DIA X11.5" L	1	AIR SUPPLY PLUMBING	AT	SEPARATE
ASP-Z03-T2ALLZ	TUBES, T2ALLZ 2.5 DIA.	1	AIR SUPPLY PLUMBING	AT	SEPARATE
ASP-Z04-T5LZ	TUBES, T5LZ 2 DIA.	1	AIR SUPPLY PLUMBING	AT	SEPARATE
ASP-Z05-T5RZ	TUBES, T5RZ 2 DIA. (MAJOR BEND=75DEG.)	1	AIR SUPPLY PLUMBING	AT	SEPARATE
ASP-Z06-T6RZ	TUBES, T6RZ 2 DIA.	1	AIR SUPPLY PLUMBING	AT	SEPARATE
CS-GZ01-H516	HOSE, 5/16X" EPDM TURBO COOLANT	10	COOLANT SYST	MM	COOLANT SYSTEM
CS-GZ02-H12	HOSE, 1/2 EPDM H2O EXTENDS OIL COOLER OUT	1.2	COOLANT SYST	MM	COOLANT SYSTEM
CS-GZ03-FT12	FITTING, H2O 1/2X1/2X3/8 TEE IN FROM OIL COOLR IN	1	COOLANT SYST	MM	COOLANT SYSTEM
CS-GZ04-FT516	FITTING, H2O 5/16X5/16X5/16TEE L/R IN OUT & RETURN	3	COOLANT SYST	MM	COOLANT SYSTEM
CS-GZ05-F9012	FITTING, H2O 1/2 90 EXTENSION	1	COOLANT SYST	MM	COOLANT SYSTEM
CS-GZ06-WBNJO	WASHER, COPPER BANJO SEALS	8	COOLANT SYST	MM	COOLANT SYSTEM
CS-GZ07-FBNJB	FITTING, BANJO BOLT TURBO H2O	4	COOLANT SYST	MM	COOLANT SYSTEM
CS-GZ08-FBNJO	FITTING, BANJO TURBO H2O IN/OUT	4	COOLANT SYST	MM	COOLANT SYSTEM
CS-GZ09-CL06	CLAMP, #06 H2O HOSES	5	COOLANT SYST	MM	COOLANT SYSTEM
CS-GZ10-CL04	CLAMP, #04 H2O HOSES	13	COOLANT SYST	MM	COOLANT SYSTEM
CS-GZ11-CA58	CLAMP, CUSHION TYPE 5/8"	1	COOLANT SYST	MM	COOLANT SYSTEM
CS-GZ12-B6X25	BOLT, M6X25MM C/CLAMP	1	COOLANT SYST	MM	COOLANT SYSTEM
CS-GZ13-W6F	WASHER, M6 FLAT C/CLAMP	1	COOLANT SYST	MM	COOLANT SYSTEM
CS-GZ14-N6NL	NUT, M6 NYLON CUSHION CLAMP MOUNTING	1	COOLANT SYST	MM	COOLANT SYSTEM
EMDP-GZ01-CCMANL	CASTING, LT EX MANIFOLD	1	EX MANIFOLDS / DOWN PIPES	MD	SEPARATE
EMDP-GZ02-CCMANR	CASTING, RT EX MANIFOLD	1	EX MANIFOLDS / DOWN PIPES	MD	SEPARATE
EMDP-GZ03-CCDPL	CASTING, LT TURBO DOWN PIPE	1	EX MANIFOLDS / DOWN PIPES	MD	SEPARATE
EMDP-GZ04-CCDPR	CASTING, RT TURBO DOWN PIPE	1	EX MANIFOLDS / DOWN PIPES	MD	SEPARATE
EMDP-GZ05-ST8X30	STUD, M8X30 OAL MAN. TURBO INLET STUD	8	EX MANIFOLDS / DOWN PIPES	MD	MAN HW
EMDP-GZ06-N10CL	NUT, M10 LOCK HEAD/MAN 10X1.25	12	EX MANIFOLDS / DOWN PIPES	MD	MAN HW
EMDP-GZ07-N8CL	NUT, M8 LOCK MANIFOLD TO TURBO INLET	8	EX MANIFOLDS / DOWN PIPES	MD	MAN HW
EMDP-GZ08-B6X8	BOLT, M6X8MM MAN/SHIELD PANHEAD ALLEN S/S	6	EX MANIFOLDS / DOWN PIPES	MD	MAN HW
EMDP-GZ09-B10X35	BOLT, M10X35MM RT D/PIPE TO CAT. REPLCS STUD	1	EX MANIFOLDS / DOWN PIPES	MD	MAN HW
EMDP-GZ09-SHMANL	SHIELD, HEAT MANIFOLD LEFT	1	EX MANIFOLDS / DOWN PIPES	MM	SHIELD MAN.
EMDP-GZ10-SHMANR	SHIELD, HEAT MANIFOLD RIGHT	1	EX MANIFOLDS / DOWN PIPES	MM	SHIELD MAN.
FLHS-GZ01-SFLSS	SHIELD, HEAT FUEL LINES S/STEEL	1	FUEL LINE HEAT SHIELD	MM	F/SHIELD
FLHS-GZ02-SPFLS	SPACER, FUEL LINE SHIELD	1	FUEL LINE HEAT SHIELD	MM	F/SHIELD
FLHS-GZ03-W6BDY	WASHER, M6 BODY	1	FUEL LINE HEAT SHIELD	MM	F/SHIELD
FLHS-GZ04-W6L	WASHER, M6 LOCK	1	FUEL LINE HEAT SHIELD	MM	F/SHIELD
FLHS-GZ05-B6X55	BOLT, M6X55MM FUEL LINE SHIELD	1	FUEL LINE HEAT SHIELD	MM	F/SHIELD
FLHS-GZ06-B8X12	BOLT, M8X12MM FUEL LINE SHIELD	2	FUEL LINE HEAT SHIELD	MM	F/SHIELD
FLHS-GZ07-W8L	WASHER, M8 LOCK	2	FUEL LINE HEAT SHIELD	MM	F/SHIELD
PPFMU-GZ01-FPMP	PUMP, FUEL 190 HI-FLOW	1	FUEL PUMP / FMU SYSTEM	MM	F/PUMP FMU KIT
PPFMU-GZ02-T18NYL	TUBING, 1/8 NYLON FMU W/1/4 NIPPLE ON END	10	FUEL PUMP / FMU SYSTEM	MM	F/PUMP FMU KIT
PPFMU-GZ04-H14	HOSE, 1/4" COMP OUT TO 1/8" REDUCER	3	FUEL PUMP / FMU SYSTEM	MM	F/PUMP FMU KIT
PPFMU-GZ05-CL04	CLAMP, #04 SIGNAL HOSE C/OUT TO 1/8" ADAPT.	2	FUEL PUMP / FMU SYSTEM	MM	F/PUMP FMU KIT
PPFMU-GZ06-F18BH	FITTING, BULKHEAD AT TANK	1	FUEL PUMP / FMU SYSTEM	MM	F/PUMP FMU KIT
PPFMU-GZ07-FMU	FMU, FUEL MANAGEMENT UNIT	1	FUEL PUMP / FMU SYSTEM	MM	F/PUMP FMU KIT
PPFMU-GZ09-OFTNK	ORING, FUEL TANK ASSEMBLY	1	FUEL PUMP / FMU SYSTEM	MM	F/PUMP FMU KIT
GASK-GZ01-GTRBO	GASKETS, TURBO INLET	2	GASKETS	MD	MAN HW
ICHW-Z01-IC350	INTERCOOLER, ASSEMBLY 350Z	1	INTERCOOLERS / IC HARDWARE	IC	SEPARATE
ICHW-Z02-BR1C	BRACKET, OUTER MNT INTERCOOLER	2	INTERCOOLERS / IC HARDWARE	IC	IC MNTING KIT
ICHW-Z03-B8X25	BOLT, M8X25MM IC OUTER BRAC TO BUMPER	2	INTERCOOLERS / IC HARDWARE	IC	IC MNTING KIT
ICHW-Z04-N8	NUT, M8 OUTER IC BRACKET TO BUMPER	2	INTERCOOLERS / IC HARDWARE	IC	IC MNTING KIT
ICHW-Z05-W8L	WASHER, M8 LOCK OUTER BRACKET ALL	4	INTERCOOLERS / IC HARDWARE	IC	IC MNTING KIT
ICHW-Z06-B8X16	BOLT, M8X16MM IC MOUNT TO BRAC OUTBOARD	2	INTERCOOLERS / IC HARDWARE	IC	IC MNTING KIT

IC HW-Z07-B10X60	BOLT, M10X60MMX1.50 IC CENTER MOUNTING	1	INTERCOOLERS / IC HARDWARE	IC	IC MNTNG KIT
MISC-GZ01-BRPSR	BRACKET, PS RESERVOIR	1	MISC	MM	SEPARATE
MISC-GZ02-WRENCH	WRENCH, 12MM TURBO BOLTS	1	MISC	MM	MISC
MISC-GZ03-STWRAP	SHIELD, THERMAL WRAP HEAT SHIELDING	1	MISC	MM	MISC
MISC-GZ04-S58BLK	SHIELD, ABRASION 5/8 PLASTIC	10	MISC	MM	MISC
MISC-GZ05-ZIPTI	ZIP TIE, 8"L	40	MISC	MM	MISC
ORSK-GZ01-CCPAN	CASTING, OIL PAN SPACER	1	OIL RETURN/ SPACER KIT	MM	OIL RETURN KIT
ORSK-GZ02-B6X35	BOLT, M6X35MM BOLT OIL PAN SPACER	10	OIL RETURN/ SPACER KIT	MM	OIL RETURN KIT
ORSK-GZ03-SPOPU	SPACER, OIL PICKUP TUBE	1	OIL RETURN/ SPACER KIT	MM	OIL RETURN KIT
ORSK-GZ04-W6WL	WASHER, WAVE WASHER	10	OIL RETURN/ SPACER KIT	MM	OIL RETURN KIT
ORSK-GZ05-B8X45	BOLT, M8X45MM OIL P/U SPACER	2	OIL RETURN/ SPACER KIT	MM	OIL RETURN KIT
ORSK-GZ06-F5845	FITTING, 5/8 45 3/8MPT OIL RETURN RT FITTING R	1	OIL RETURN/ SPACER KIT	MM	OIL RETURN KIT
ORSK-GZ07-F5890	FITTING, 5/8 90 3/8MPT OIL RETURN LT FITTING	1	OIL RETURN/ SPACER KIT	MM	OIL RETURN KIT
ORSK-GZ08-H58	HOSE, TURBO OIL DRAIN HOSE LT, ODL	1.42	OIL RETURN/ SPACER KIT	MM	OIL RETURN KIT
ORSK-GZ09-H58	HOSE, TURBO OIL DRAIN HOSE RT, ODR	1.1	OIL RETURN/ SPACER KIT	MM	OIL RETURN KIT
ORSK-GZ10-F58SPL	FITTING, 5/8" TURBO OIL OUT FLNG	2	OIL RETURN/ SPACER KIT	MM	OIL RETURN KIT
ORSK-GZ11-B8X20	BOLT, M8X20MM TURBO DRAIN FLANGE	4	OIL RETURN/ SPACER KIT	MM	OIL RETURN KIT
ORSK-GZ12-W8L	WASHER, LOCK M8	4	OIL RETURN/ SPACER KIT	MM	OIL RETURN KIT
ORSK-GZ13-CL10	CLAMP, #10 OIL RET. HOSES	4	OIL RETURN/ SPACER KIT	MM	OIL RETURN KIT
RVPCV-GZ01-RV	RECIRC VALVE	1	RECIRC VALVE SYST / PCV HOSE EXT.	MM	RECIRC VALVE/PCV EXT KIT
RVPCV-GZ02-H1	HOSE, RECIRC VALVE IN/OUT 1"	1.5	RECIRC VALVE SYST / PCV HOSE EXT.	MM	RECIRC VALVE/PCV EXT KIT
RVPCV-GZ03-CL20	CLAMP, #20 RECIRC IN/OUT	4	RECIRC VALVE SYST / PCV HOSE EXT.	MM	RECIRC VALVE/PCV EXT KIT
RVPCV-GZ04-H532	HOSE, 5/32" REINF. VAC - SIGNAL LINE	3	RECIRC VALVE SYST / PCV HOSE EXT.	MM	RECIRC VALVE/PCV EXT KIT
RVPCV-GZ05-H58	HOSE, PCV EXT. 5/8X14	1	RECIRC VALVE SYST / PCV HOSE EXT.	MM	RECIRC VALVE/PCV EXT KIT
RVPCV-GZ06-F58ST	FITTING, 5/8 ST BARB COUPLING PCV EXT.	1	RECIRC VALVE SYST / PCV HOSE EXT.	MM	RECIRC VALVE/PCV EXT KIT
RVPCV-GZ07-CL10	CLAMP, #10 PCV EXT.	2	RECIRC VALVE SYST / PCV HOSE EXT.	MM	RECIRC VALVE/PCV EXT KIT
STU-GZ01-STUNIT	SPARK TIMING UNIT	1	SPARK TIMING UNIT	MM	STU BOX
TOS-GZ01-TO1M	TUBING, TURBO OIL IN MAIN, O1M	1	TURBO OIL SUPPLY	MM	TURBO OIL SUPPLY KIT
TOS-GZ02-TO2L	TUBING, TURBO OIL IN LEFT, O2L	1	TURBO OIL SUPPLY	MM	TURBO OIL SUPPLY KIT
TOS-GZ03-TO1L	TUBING, TURBO OIL INTER LEFT O1L	1	TURBO OIL SUPPLY	MM	TURBO OIL SUPPLY KIT
TOS-GZ04-TO1R	TUBING, TURBO OIL INTER RIGHT O1R	1	TURBO OIL SUPPLY	MM	TURBO OIL SUPPLY KIT
TOS-GZ05-TO2R	TUBING, TURBO OIL IN RIGHT, O2R	1	TURBO OIL SUPPLY	MM	TURBO OIL SUPPLY KIT
TOS-GZ06-F18ST	FITTING, 1/8 STREET T OIL IN AT ENG OIL SENDER	1	TURBO OIL SUPPLY	MM	TURBO OIL SUPPLY KIT
TOS-GZ07-FRES	FITTING, OIL RESTRICTOR .050" 1/4INX1/8MPT	1	TURBO OIL SUPPLY	MM	TURBO OIL SUPPLY KIT
TOS-GZ08-F14TEE	FITTING, 1/4 INV FLR TEE MAIN TO LT/RT	1	TURBO OIL SUPPLY	MM	TURBO OIL SUPPLY KIT
TOS-GZ09-F14CPL	FITTING, 1/4" INV FLR CPLING INTER/TURB IN LT/RT	2	TURBO OIL SUPPLY	MM	TURBO OIL SUPPLY KIT
TOS-GZ10-CA14	CLAMP, CUSHION 1/4" OIL SUP TO ENG BLK.	1	TURBO OIL SUPPLY	MM	TURBO OIL SUPPLY KIT
TOS-GZ11-B6X10	BOLT, M6X10MM CUSH CLAMP TO ENG BLK	1	TURBO OIL SUPPLY	MM	TURBO OIL SUPPLY KIT
TOS-GZ12-W6L	WASHER, M6 LOCK	1	TURBO OIL SUPPLY	MM	TURBO OIL SUPPLY KIT
TURBO-GZ01-TURBOL	TURBOCHARGER LEFT SIDE	1	TURBOCHARGERS	TU	SEPARATE
TURBO-GZ02-TURBOR	TURBOCHARGER RIGHT SIDE	1	TURBOCHARGERS	TU	SEPARATE
TURBO-GZ03-ST8X41	STUD, M8X41 TURBO OUTLET STUD	10	TURBOCHARGERS	MD	TURBO OUT HW
TURBO-GZ04-N8CL	NUT, M8 LOCK TURBO OUTLET	10	TURBOCHARGERS	MD	TURBO OUT HW
WGSL-GZ01-H14X96	HOSE, 1/4" REINFORCED VAC 8' LONG	8	WASTE GATE SIGNAL LINES	MM	W/GATE SIGNAL HOSE KIT
WGSL-GZ02-CL04	CLAMP, #04 W/GATE SIGNAL HOSE	4	WASTE GATE SIGNAL LINES	MM	W/GATE SIGNAL HOSE KIT
WGSL-GZ03-F18X14T	FITTING, 1/8NPT X 1/4" BARB TEE PLASTIC	1	WASTE GATE SIGNAL LINES	MM	W/GATE SIGNAL HOSE KIT
WWR-GZ02-CA3	CLAMP, CUSHION 3"D	1	WINDSHIELD WASH RESERVOIR	MM	W/WASHER
WWR-Z01-RTNK	RESERVOIR, W/WASHER 350Z ONLY	1	WINDSHIELD WASH RESERVOIR	MM	W/WASHER
WWR-Z03-H58X24	HOSE, 5/8 X 2' W/WASH TANK FILL	2	WINDSHIELD WASH RESERVOIR	MM	W/WASHER
WWR-Z04-THS125	TUBE, HEAT SHRINK 1.25D X4"	0.3	WINDSHIELD WASH RESERVOIR	MM	W/WASHER
WWR-Z05-H14CLR	HOSE, 1/4 X 2' VINYL CLEAR W/W TANK VENT	2	WINDSHIELD WASH RESERVOIR	MM	W/WASHER



AF-Z01-APC.jpg



AF-Z02-SHSTRP.jpg



AF-Z03-SHMAIN.jpg



AF-Z04-SHT0X11.j...



AF-Z05-SHT3X54.j...



ASP-GZ01-CL32.jpg



ASP-GZ02-CL36.jpg



ASP-GZ03-CL48.jpg



ASP-GZ04-T2L.jpg



ASP-GZ05-T2R.jpg



ASP-GZ06-T3A.jpg



ASP-GZ07-T3L.jpg



ASP-GZ08-T3R.jpg



ASP-GZ09-T4L.jpg



ASP-GZ10-T4R.jpg



ASP-GZ11-H10A.J...

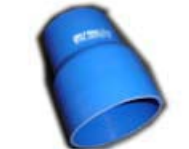

ASP-GZ12-H11A.J...



ASP-GZ13-H12A.J...



ASP-GZ14-H1A.JPG



ASP-GZ15-H2L.JPG



ASP-GZ16-H2R.JPG



ASP-GZ17-H3L.JPG



ASP-GZ18-H3R.JPG



ASP-GZ19-H4L.JPG



ASP-GZ20-H4R.JPG



ASP-GZ21-H5L.JPG



ASP-GZ22-H5R.JPG



ASP-GZ23-H6L.JPG



ASP-GZ24-H6R.JPG



ASP-GZ25-H7R.JPG



ASP-GZ26-H8R.JPG



ASP-GZ27-H9A.JPG



ASP-GZ28-W6L.jpg



ASP-GZ29-W6DY.jpg



ASP-GZ30-W6L.jpg



ASP-GZ31-W6F.jpg



ASP-Z01-CCT1Z.jpg



ASP-Z02-T1ALL.jpg



ASP-Z03-T2ALL.j...



ASP-Z06-T6RZ.jpg



ASP-Z05-T5RZ.jpg



ASP-Z04-T5LZ.jpg



CS-GZ01-H516.jpg



CS-GZ02-H12.jpg



CS-GZ03-FT12.jpg



CS-GZ04-FT516.jpg



CS-GZ05-F9012.jpg



CS-GZ06-WBNJO.jpg



CS-GZ07-FBNJB.jpg



CS-GZ08-FBNJO.jpg



CS-GZ09-CL06.jpg



CS-GZ10-CL04.jpg



CS-GZ11-CA58.jpg



CS-GZ12-B6X25.jpg



CS-GZ13-W6F.jpg



CS-GZ14-N6NL.jpg



EMDP-GZ01-CCM...



EMDP-GZ02-CCM...



EMDP-GZ03-CCDP...



EMDP-GZ04-CCDP...



EMDP-GZ05-ST8X...



EMDP-GZ06-N10C...



EMDP-GZ07-N8CL...



EMDP-GZ09-B6X8...



EMDP-GZ09-SHM...



EMDP-GZ10-SHM...



FLHS-GZ01-SFLSS...



FLHS-GZ02-SPFLS...



FLHS-GZ03-W6DY...



FLHS-GZ04-W6L.jpg



FLHS-GZ05-B6X55...



FLHS-GZ06-B8X12...



FLHS-GZ07-W8L.jpg



FPFMU-GZ01-FPM...



FPFMU-GZ02-T18...



FPFMU-GZ04-H14....



FPFMU-GZ05-CL0...



FPFMU-GZ06-F18...



FPFMU-GZ07-FMU...



FPFMU-GZ09-OFT...



GASK-GZ01-G... ICHW-Z01-IC3... ICHW-Z02-BRI... ICHW-Z03-B8X... ICHW-Z04-NBj... ICHW-Z05-WB... ICHW-Z06-B8X... ICHW-Z07-B10...



MISC-GZ01-B... MISC-GZ02-W... MISC-GZ03-S... MISC-GZ04-S5... MISC-GZ05-ZI... ORSK-GZ01-C... ORSK-GZ02-B... ORSK-GZ03-S...



ORSK-GZ04-W... ORSK-GZ05-B... ORSK-GZ06-F... ORSK-GZ07-F... ORSK-GZ08-H... ORSK-GZ09-H... ORSK-GZ10-F... ORSK-GZ11-B...



ORSK-GZ12-W... ORSK-GZ13-C... RVPCV-GZ01... RVPCV-GZ02... RVPCV-GZ03... RVPCV-GZ04... RVPCV-GZ05... RVPCV-GZ06...



RVPCV-GZ07... STU-GZ01-ST... TOS-GZ01-TO... TOS-GZ02-TO... TOS-GZ03-TO... TOS-GZ04-TO... TOS-GZ05-TO... TOS-GZ06-F18...



TOS-GZ07-FR... TOS-GZ08-F14... TOS-GZ09-F14... TOS-GZ10-CA... TOS-GZ11-B6... TOS-GZ12-W6... TURBO-GZ01... TURBO-GZ02...



TURBO-GZ03... TURBO-GZ04... WGS�-GZ01-H... WGS�-GZ02-C... WGS�-GZ03-F... WWR-GZ02-C...